

SDM630MCT V2

DIN Rail Energy Meter for Single and Three Phase Electrical Systems



- Measures kWh Kvarh, KW, Kvar, KVA, P, F, PF, Hz, dmd, V, A, THD,etc.
- Bi-directional measurement IMP & EXP
- Two pulse outputs
- RS485 Modbus
- Din rail mounting 35mm
- 1/5A CT connection
- Better than Class 1 / B accuracy

USER MANUAL V5.0

Introduction

This document provides operating, maintenance and installation instructions. The unit measures and displays the characteristics of single phase two wires (1p2w), three phase three wires(3p3w,) and three phase four wires(3p4w) supplies, including voltage, frequency, current, power ,active and reactive energy, imported or exported. Energy is measured in terms of kWh, kVAh. Maximum demand current can be measured over preset periods of up to 60minutes. In order to measure energy, the unit requires voltage and current inputs in addition to the supply required to power the product. The requisite current input(s) are obtained via current transformers(CT).

This meter can be configured to work with a wide range of CTs, giving the unit a wide range of operation. Built-in interfaces provides pulse and RS485 Modbus RTU outputs. Configuration is password protected.

This unit can be powered from a separate auxiliary (AC or DC) supply. Alternatively it can be powered from the monitored supply, where appropriate.

Unit Characteristics

The Unit can measure and display:

- Line voltage and THD% (total harmonic distortion) of all phases
- Line Frequency
- Currents, Current demands and current THD% of all phases
- Power, maximum power demand and power factor
- Active energy imported and exported
- Reactive energy imported and exported

The unit has password-protected set-up screens for:

- Changing password
- Supply system selection 1p2w, 3p3w,3p4w
- Demand Interval time
- Reset for demand measurements
- Pulse output duration

Two pulse output indicates real-time energy measurement. An RS485 output allows remote monitoring from another display or a computer.

Current Transformer Primary Current

The unit can be configured to operate with CT ratio between primary current and secondary current. The secondary CT has two options: 1A/5A

RS485 Serial - Modbus RTU



This uses an RS485 serial port with Modbus RTU protocol to provide a means of remotely monitoring and controlling the Unit

Set-up screens are provided for setting up the RS485 port.

Pulse output

This provides two pulse outputs that clock up measured active and reactive energy. The constant for active energy is 3200imp/kWh(Terminals 11&12). The pulse width for pulse 1(Terminals 9&10) can be set from the set-up menu.

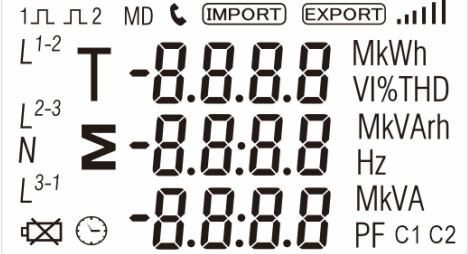

Start Up Screens

1	 <p>The first screen displays various meters and status indicators: 1L 2L MD, IMPORT, EXPORT, signal strength, L¹⁻² T -0.0.0.0 MkWh, L²⁻³ N Σ -0.0.0.0 VI%THD, L³⁻¹ -0.0.0.0 Hz, and PF C1 C2.</p>	The first screen lights up all display segments and can be used as a display check.
2	 <p>The second screen displays the firmware version and build number: Soft 1.231 2014.</p>	The second screen indicates the firmware installed in the unit and its build number.
3	 <p>The third screen displays the self-test results: 175t, 665t, PASS.</p>	The interface performs a self-test and indicates the result if the test passes.

*After a short delay, the screen will display active energy measurements.

Measurements

The buttons operate as follows:

1		Selects the Voltage and Current display screens In Set-up Mode, this is the "Left" or "Back" button.
2		Select the Frequency and Power factor display screens In Set-up Mode, this is the "Up" button
3		Select the Power display screens In Set-up Mode, this is the "Down" button

4		Select the Energy display screens In Set-up mode, this is the “Enter” or “Right” button
---	--	--

Voltage and Current



Each successive pressing of the button selects a new range:

1-1		Phase to neutral voltages(3p4w)
1-2		Phase to Phase voltages(3p3w)
2		Current on each phase
2-1		Neutral current
3-1		Phase to neutral voltage THD%(3p4w)

3-2		Phase to Phase voltage THD%(3p3w)
4		Current THD% for each phase

Frequency and Power factor and Demand



Each successive pressing of the button selects a new range:

1		Frequency and Power Factor (total)
2		Power Factor of each phase
3		Maximum Power Demand

4		Maximum Current Demand
---	--	------------------------

Power







Each successive pressing of the  button select a new range:

1		Instantaneous Active Power in kW
2		Instantaneous Reactive Power in kVAr
3		Instantaneous Volt-amps in kVA
4		Total kW, kVArh, kVA

Energy Measurements



Each successive pressing of the button selects a new range:

1-1		Total active energy in kWh
1-2		Total reactive energy in kVarh
2-1		Imported active energy in kWh
2-2		Exported active energy in kWh
3-1		Imported reactive energy in kVarh

3-2		Exported reactive energy in kVArh
-----	--	-----------------------------------

Setting Up

To enter set-up mode, pressing the button for 3 seconds, until the password screen appears.



Setting up is password-protected so you must enter the correct password (default '1000') before processing.

If an incorrect password is entered, the display will show: PASS Err









To exit setting-up mode, press repeatedly until the measurement screen is restored.

Set-up Entry Methods

Some menu items, such as password and CT, require a four-digit number entry while others, such as supply system, require selection from a number of menu options.





Menu Option Selection

- 1) Use the and buttons to select the required item from the menu. Selection does not roll over between bottom and top of list
- 2) Press to confirm your selection

- 3) If an item flashes, then it can be adjusted by the  and  buttons. If not, there maybe a further layer.
- 4) Having selected an option from the current layer, press  to confirm your selection.
- 5) Having completed a parameter setting, press  to return to a higher menu level. You will be able to use the  and  buttons for further menu selection.
- 6) On completion of all setting-up, press  repeatedly until the measurement screen is restored.

Number Entry Procedure

When setting up the unit, some screens require the entering of a number. In particular, on entry to the setting up section, a password must be entered. Digits are set individually, from left to right. The procedure is as follows:

- 1) The current digit to be set flashes and is set using the  and  buttons
- 2) Press  to confirm each digit setting.
- 3) After setting the last digit, press  to exit the number setting routine.



Communication

There is a RS485 port can be used for communication using Modbus RTU protocol. For Modbus RTU, parameters are selected from Front panel.

RS485 Address



(The range is from 001 to 247)

1		<p>From the Set-up menu, use </p> <p>and  buttons to select the Address ID</p>
---	--	---

2-1		Press button to enter the selection routine. The current setting will be flashing.
2-2		Use and buttons to choose Modbus Address(001 to 247)
On completion of the entry procedure, press button to confirm the setting and press button to return the main set-up menu.		

Baud Rate

1		From the Set-up menu, use and buttons to select the Baud Rate option.
2-1		Press to enter the selection routine. The current setting will flash.
2-2		Use and buttons to choose Baud rate 2.4k, 4.8k, 9.6k, 19.2k, 38.4k Default is 9.6k

On completion of the entry procedure, press to confirm the setting and press to return to the main set up menu.

Parity

1		From the Set-up menu, use and buttons to select the Parity option.
2-1		Press to enter the selection routine. The current setting will flash.
2-2		Use and buttons to choose Parity (EVEN / ODD/ NONE) Default is NONE.
On completion of the entry procedure, press to confirm the setting and press to return to the main set up menu.		

Stop bits

1		From the Set-up menu, use and buttons to select the Stop Bit option.
---	--	--

2-1		Press to enter the selection routine. The current setting will flash.
2-2		Use and buttons to choose Stop Bit (2 or 1)
On completion of the entry procedure, press to confirm the setting and press to return to the main set up menu.		

Note: Default is 1, and only when the parity is NONE that the stop bit can be changed to 2.

CT

The CT option sets the secondary current (CT2 1A or 5A) of the current transformer (CT) that wires to the meter.

1		From the Set-up menu, use and buttons to select the CT option.
2		Secondary CT setting Press to enter the CT secondary current selection routine.:5A/1A

3		<p>Set CT Ratio value</p> <p>Press to enter the CT Ratio setting screen. The range is from 0001 to 2000.</p>
<p>Example: If set the ratio to be 100, it means the primary current equals secondary current x 100</p>		

PT

The PT option sets the secondary voltage (PT2 100 to 500V) of the Voltage transformer (PT) that wires to the meter.

1		<p>From the Set-up menu, use and buttons to select the PT option. The screen will show the voltage PT secondary voltage value. The default value is 400V</p>
2		<p>Secondary PT setting</p> <p>Press to enter the PT secondary voltage selection routine. The range is from 100 to 500V</p>
3		<p>Set PT ratios value</p> <p>Press to enter the PT ratio screen. The range is from 0001 to 2000</p>
<p>For example, if set the ratio to be 100, it means the primary voltage equals secondary voltage x 100</p>		

Pulse output

This option allows you to configure the pulse output. The output can be set to provide a pulse for a defined amount of energy active or reactive.

Use this section to set up the pulse output 1—Units: Total kWh, Total kVARh

1		<p>From the Set-up menu, use and buttons to select the Pulse output option.</p>
2		<p>Press to enter the selection routine. The unit symbol will flash.</p>
3		<p>Use and buttons to choose kWh or kVArh.</p>
<p>On completion of the entry procedure, press to confirm the setting and press to return to the main set up menu.</p>		

Pulse rate

Use this to set the energy represented by each pulse. Rate can be set to 1 pulse per 0.01kWh/0.1kWh/1kWh/10kWh/100/1000kWh.



(It shows 1 impulse = 10kWh/kVArh)

1		<p>From the Set-up menu, use and buttons to select the Pulse Rate option.</p>
2		<p>Press to enter the selection routine. The current setting will flash. 0.01/0.1/1/10/100/1000kWh/kVArh per pulse</p>
<p>Use and buttons to choose pulse rate. On Completion of the entry procedure, press to confirm the setting and press to return to the main set up menu.</p>		

Pulse Duration

The energy monitored can be active or reactive and the pulse width can be 200, 100 or 60ms.



(It shows pulse width of 200ms)

1-1		<p>From the Set-up menu, use and buttons to select the Pulse width option.</p>
1-2		<p>Press to enter the selection routine. The current setting will flash. Use and buttons to choose pulse width.</p>

On completion of the entry procedure, press to confirm the setting and press to return to the main set up menu.

DIT Demand Integration Time

This sets the period in minutes over which the current and power readings are integrated for maximum demand measurement. The options are: off, 5, 8, 10, 15, 20, 30, 60 minutes

1		<p>From the set-up menu, use and buttons to select the DIT option. The screen will show the currently selected integration time.</p>
2-1		<p>Press to enter the selection routine. The current time interval will flash</p>
2-2		<p>Use and buttons to select the time required.</p>
2-3		<p>Press to confirm the selection. SET indicator will appear.</p>
<p>Press to exit the DIT selection routine and return to the menu.</p>		

Backlit set-up



The meter provides a function to set the blue backlit lasting time.

1		<p>The backlit lasting time is settable Default lasting time is 60minutes For example, if it's set as 5, the backlit will be off in 5minutes from the last time operation on the meter. Notes: If it's set as 0, the backlit will always be on.</p>
2		<p>Press to enter the selection routine. The current time interval will flash The options can be: 0/5/10/30/60/120minutes</p>
<p>Use and buttons to select the time required. Then press to confirm the set-up,</p>		

Supply System







Use this section to set the type of power supply being monitored.

1		<p>From the Set-up menu, use and buttons to select the System option. The screen will show the currently selected power supply.</p>
2		<p>Press to enter the selection routine. The current selection will flash</p>
3-1		<p>Use and buttons to select the required system option: 1P2(W),3P3(W) ,3P4(W)</p>



3-2		Press  to confirm the selection. SET indicator will appear.
Press  to exit the system selection routine and return to the menu. SET will disappear and you will be returned to the main Set-up Menu		









CLR

The meter provides a function to reset the maximum demand value of current and power.



1		From the Set-up menu, use  and  buttons to select the reset option.
2		Press  to enter the selection routine. The MD will flash.
Press  to confirm the setting and press  to return to the main set up menu.		

Change password

1		Use the  and  to choose the change password option
---	---	--

2-1		<p>Press the  to enter the change password routine. The new password screen will appear with the first digit flashing</p>
2-2		<p>Use  and  to set the first digit and press  to confirm your selection. The next digit will flash.</p>
2-3		<p>Repeat the procedure for the remaining three digits</p>
2-4		<p>After setting the last digit, SET will show.</p>
<p>Press  to exit the number setting routine and return to the Set-up menu. SET will be removed</p>		

Reverse connected current inputs correction set-up

1		<p>use  and  buttons to select page "SET sys cont"</p>
---	---	---

2-1		Press to enter Phase A , the default is Frd (forward)
2-2		use and buttons to Phase B or C setting pages

How to operate if phase A is reversely connected

1		Go to phase A setting page
2		Press to enter the selection routine. The Frd will flash. Use button to change Frd to Rev.
Press to confirm the setting and press to return to the main set up menu.		

Specifications

Measured Parameters

The unit can monitor and display the following parameters of a single phase two wire(1p2w), three phase three wire(3p3w) or four phase four wire(3p4w) supply.

Voltage and Current

Phase to neutral voltages 100 to 289V a.c. (not for 3p3w supplies)

Voltages between phases 173 to 480V a.c. (3p supplies only)

Percentage total voltage harmonic distortion (THD%) for each phase to N (not for 3p3w supplies)

Percentage voltage THD% between phases (three phase supplies only)

Current THD% for each phase

Power factor and Frequency and Max. Demand

Frequency in Hz

Instantaneous power:

Power 0 to 3600 MW

Reactive Power 0 to 3600 MVA

Volt-amps 0 to 3600 MVA

Maximum demanded power since last Demand reset Power factor

Maximum neutral demand current, since the last Demand reset (for three phase supplies only)

Energy Measurements

- Imported/Exported active energy 0 to 9999999.9 kWh
- Imported/Exported reactive energy 0 to 9999999.9 kVAh
- Total active energy 0 to 9999999.9 kWh
- Total reactive energy 0 to 9999999.9 kVAh

Measured Inputs

Voltage inputs through 4-way fixed connector with 2.5mm² stranded wire capacity. single phase two wire(1p2w), three phase three wire(3p3w) or four phase four wire(3p4w) unbalanced. Line frequency measured from L1 voltage or L3 voltage.

Three current inputs (six physical terminals) with 2.5mm² stranded wire capacity for connection of external CTs. Nominal rated input current 5A or 1A a.c. Rms.

Accuracy

- Voltage 0.5% of range maximum
- Current 0.5% of nominal
- Frequency 0.2% of mid-frequency
- Power factor 1% of unity (0.01)
- Active power (W) ±1% of range maximum
- Reactive power (VA) ±1% of range maximum
- Apparent power (VA) ±1% of range maximum
- Active energy (Wh) Class 1 IEC 62053-21
- Reactive energy (VAh) ±1% of range maximum
- Total harmonic distortion 1% up to 31st harmonic
- Response time to step input 1s, typical, to >99% of final reading, at 50/60 Hz.

*Auxiliary Supply

Two-way fixed connector with 2.5mm² stranded wire capacity.

85 to 275V a.c. 50/60Hz ±10% or 120V to 380V d.c. ±20%. Consumption < 10W.

Interfaces for External Monitoring

Three interfaces are provided:

- an RS485 communication channel that can be programmed for Modbus RTU protocol
- an output indicating real-time measured energy.(configurable)
- an pulse output 3200imp/kWh (not configurable)

The Modbus configuration (Baud rate etc.) and the pulse output assignments (kW/kVArh) are configured through the Set-up screens.

Pulse Output

The unit provides two pulse outputs. Both pulse outputs are passive type.

Pulse output 1 is configurable. The pulse output can be set to generate pulses to represent total kWh or kVArh.

The pulse constant can be set to generate 1 pulse per:

0.01 = 10 Wh/VArh

0.1 = 100 Wh/VArh

1 = 1 kWh/kVArh

10 = 10 kWh/kVArh

100 = 100 kWh/kVArh

1000=1000 kWh/kVArh

Pulse width: 200/100(default)/60ms

Pulse output 2 is non-configurable. It is fixed up with total kWh. The constant is 3200imp/kWh.

RS485 Output for Modbus RTU

For Modbus RTU, the following RS485 communication parameters can be configured from the Set-up menu:

Baud rate 2400, 4800, 9600(default), 19200, 38400

Parity none (default)/odd/even

Stop bits 1 or 2

RS485 network address *nnn* – 3-digit number, 001 to 247

Modbus™ Word order Hi/Lo byte order is set automatically to normal or reverse. It cannot be configured from the set-up menu.

Reference Conditions of Influence Quantities

Influence Quantities are variables that affect measurement errors to a minor degree. Accuracy is verified under nominal value (within the specified tolerance) of these conditions.

- Ambient temperature 23°C ±1°C
- Input frequency 50 or 60Hz ±2%
- Input waveform Sinusoidal (distortion factor < 0.005)
- Auxiliary supply voltage Nominal ±1%
- Auxiliary supply frequency Nominal ±1%
- Auxiliary supply waveform (if AC) Sinusoidal (distortion factor < 0.05)
- Magnetic field of external origin Terrestrial flux

Environment

Add:No.52, Dongjin Road, Nanhu, Jiaying, Zhejiang, 314001, China.

Tel: 0086-573-83698881/83698882 Fax: 0086-573-83698883 Web: www.eastron.com.cn

- Operating temperature -40°C to +70°C
- Storage temperature -40°C to +70°C
- Relative humidity 0 to 95%, non-condensing
- Altitude Up to 2000m
- Warm up time 10s
- Vibration 10Hz to 50Hz, IEC 60068-2-6, 2g
- Shock 30g in 3 planes

Dimensions

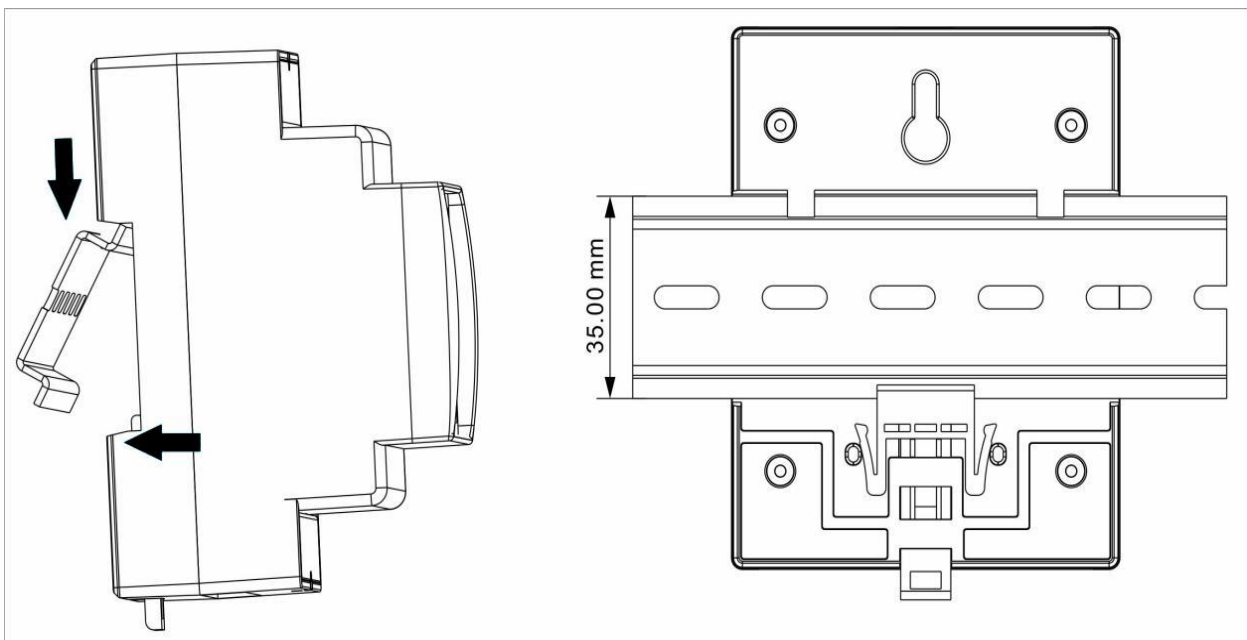
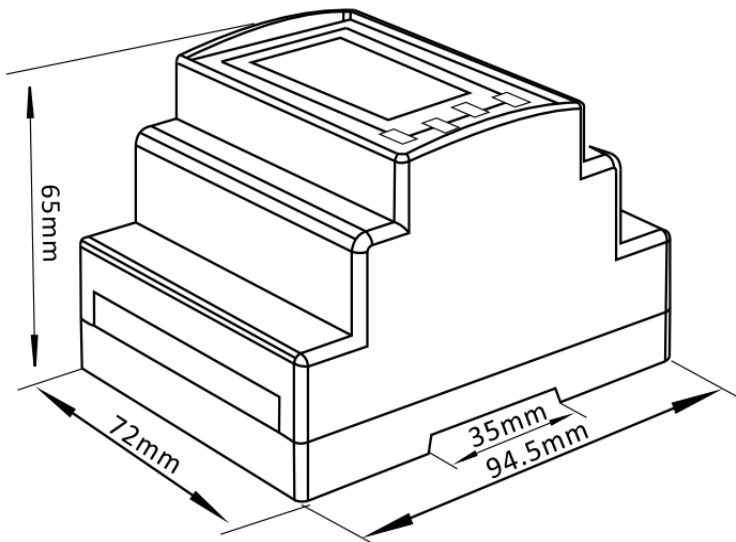

Installation

Three phase four wire 3CT

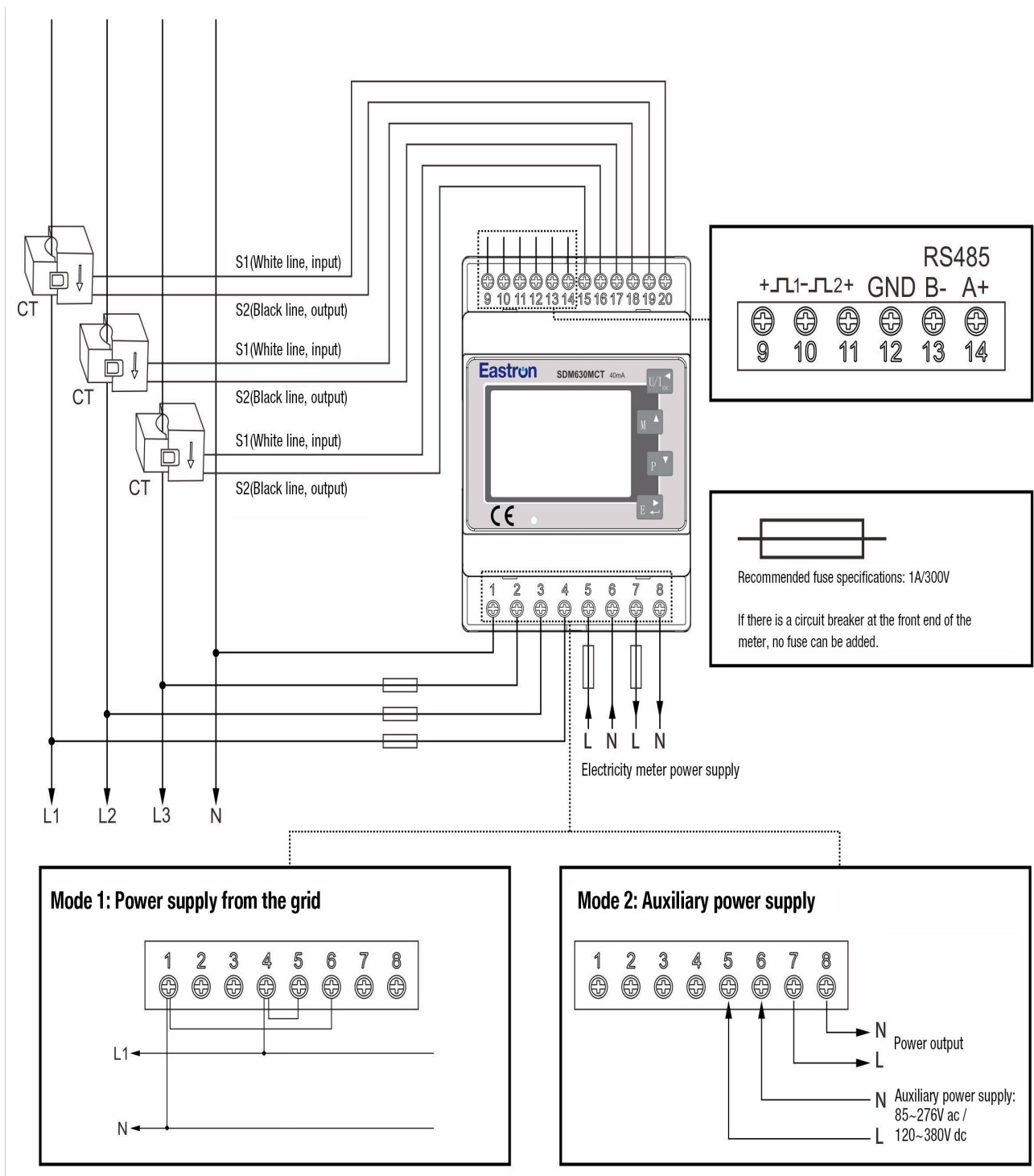

Note: The direction of current flows from the grid to the load is positive. please ensure that the direction of CT arrow is consistent with the current

three phase three wire 2CT

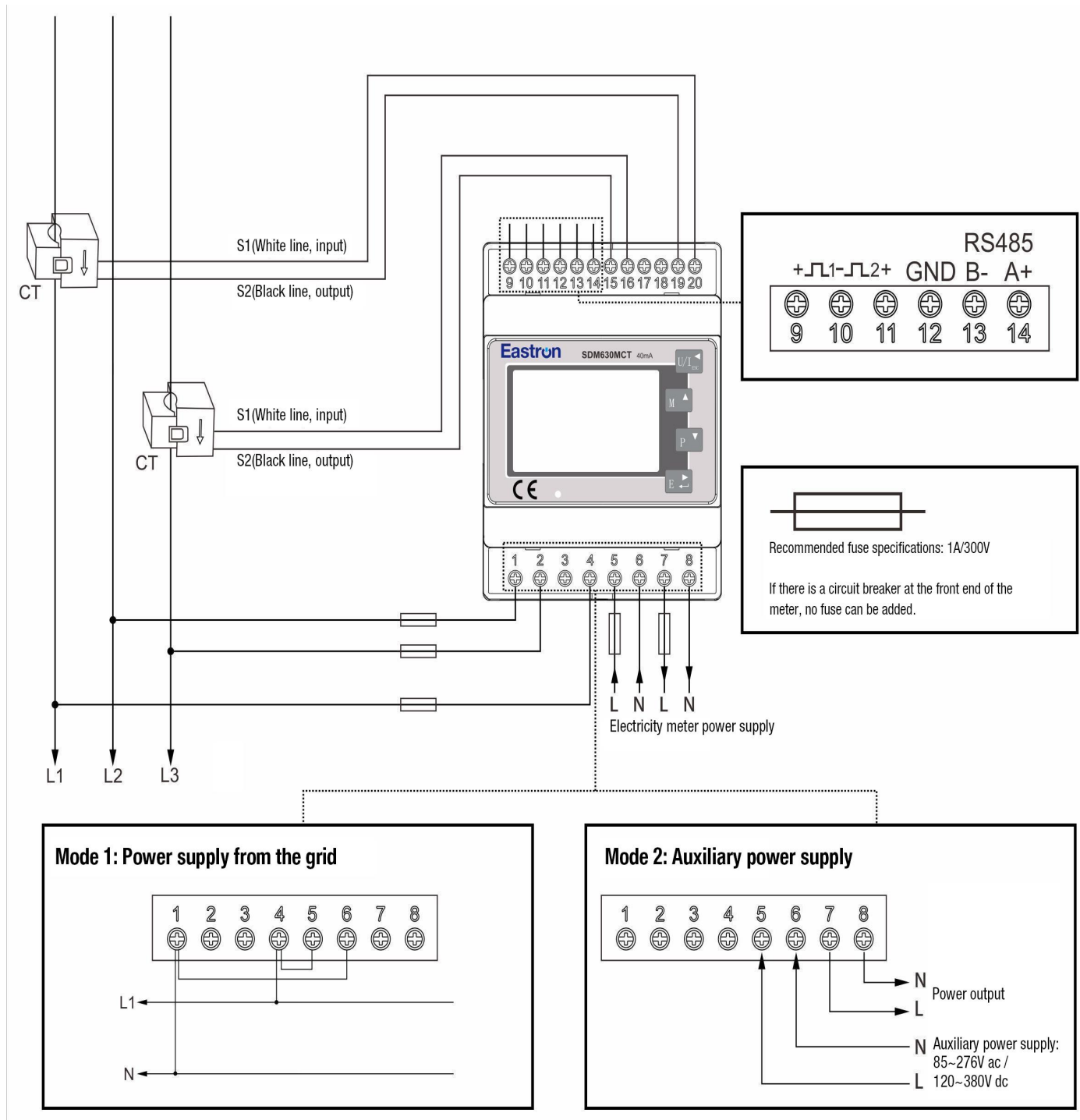

Note: The direction of current flows from the grid to the load is positive. please ensure that the direction of CT arrow is consistent with the current

Single phase two wire 1CT

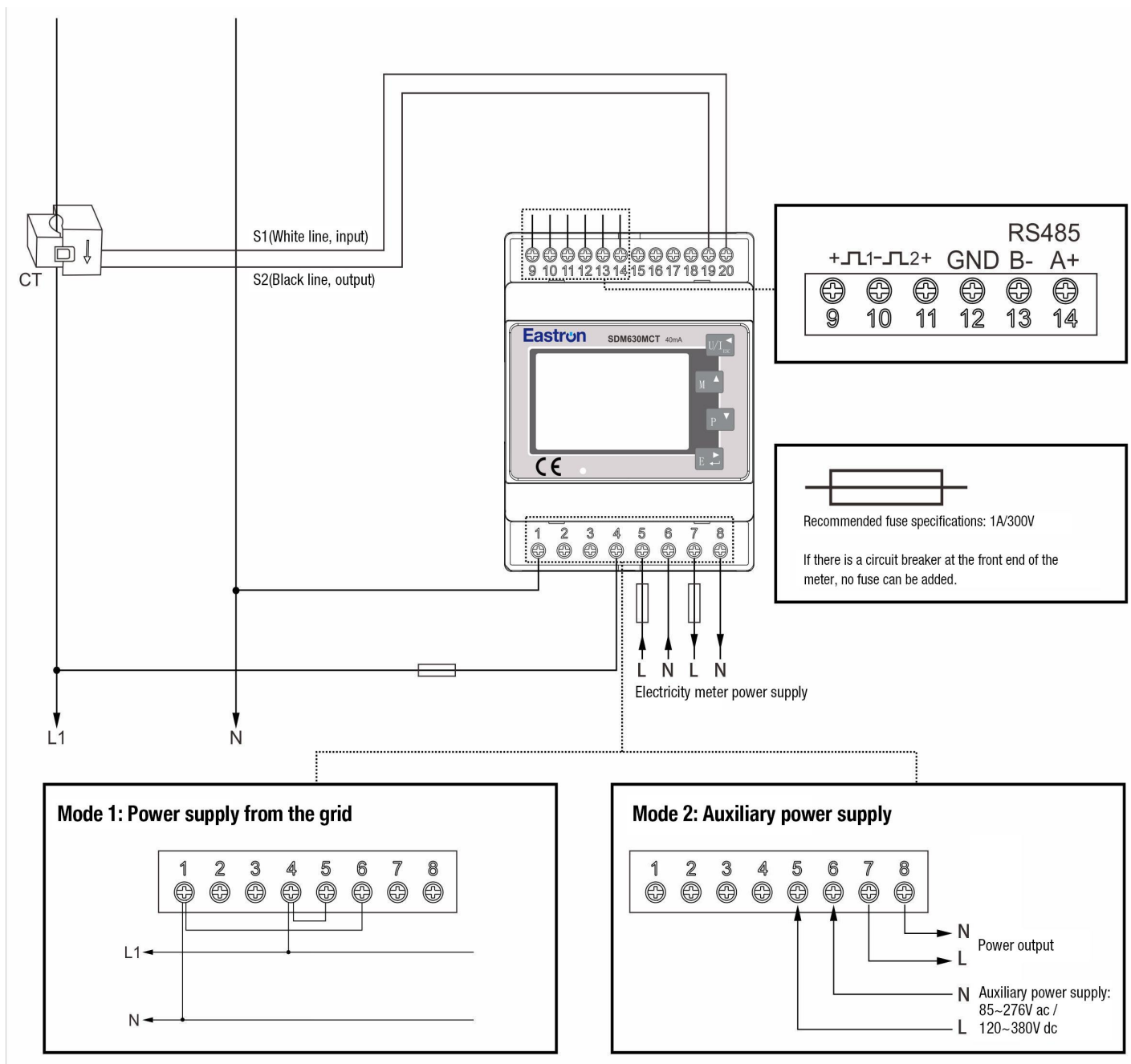

Note: The direction of current flows from the grid to the load is positive. please ensure that the direction of CT arrow is consistent with the current

Eastron Product specification

1. Product name: open and closing current transformer

2. Product specification: ESCT-T36 600A/5A

3. Main technical parameters:

Project	Symbol	technical parameter	Project	Symbol	technical parameter
Service frequency	f	50-60Hz	Insulation strength	—	500M Ω /500V/min
Rated primary current	I _n	600A	Power frequency and pressure resistance	—	4KV / 1 mA / 1min (through the cable)
Rated secondary current	I _o	5A	Working temperature	Ta	-25℃ ~ +85℃
Accuracy class	—	0.5	Storage temperature	Ts	-25℃ ~ +85℃
Rated load	VA	1	Degree of linearity	%	0.5
Operative Std	GB 20840.2-2014 / IEC61869-2				

4. Primary, secondary and polar end definitions:

4.1 Primary definition of transformer: primary penetration input of transformer and secondary lead output.

4.2 Definition of the same name of primary and secondary leads: P1 into P2 and out of P 2 of the transformer.

4.3 The electrical schematic diagram of the transformer is as follows.

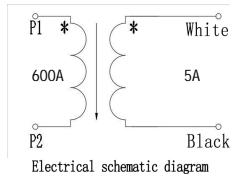

5. Main production technical requirements of the transformer:

5.1 Shell color is black.

5.2 Output mode is: 2*14AWG black and white (line arrangement), line length is 1.0m.(Tailable to customer request)

5.3 Please refer to the following figure for the overall dimensions (mm)

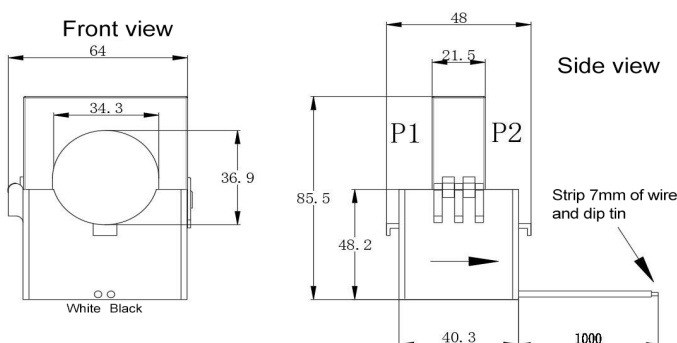

5.4 Mutual error requirements.

Accurate level	Current Error ± (%)				Phase Error ± (')			
	At the following current				At the following current			
	0.05I _n	0.2I _n	I _n	1.2I _n	0.05I _n	0.2I _n	I _n	1.2I _n
0.5	1.5	0.75	0.5	0.5	90	60	45	45