

# SigenStor Home

## User Manual

Single-phase System

A1



**Version: 01**

**Release date: 2023-07-31**



## Copyright Notice

Copyright© 2023 Sigenergy Technology Co., Ltd. All Rights Reserved.

Description in this document may contain predictive statements regarding financial and operating results, product portfolio, new technology, configurations and features of product. Several factors could cause difference between actual results and those expressed or implied in the predictive statements. Therefore, description in this document is provided for reference purpose only and constitutes neither an offer nor an acceptance. Sigenergy Technology Co., Ltd. may change the information at any time without notice.



**SIGENERGY**

and other Sigenergy trademarks are owned by Sigenergy Technology Co., Ltd.

All trademarks and registered trademarks in this document belong to their owners.



Website



LinkedIn



YouTube

**[www.sigenergy.com](http://www.sigenergy.com)**

## Contents

<b>Revision History</b> .....	<b>4</b>
<b>Overview</b> .....	<b>5</b>
<b>Chapter 1 Safety Precautions</b> .....	<b>6</b>
<b>Chapter 2 Introduction to energy storage system</b> .....	<b>9</b>
2.1 Product Introduction .....	9
2.2 Appearance Introduction .....	12
<b>2.2.1 Appearance and Dimensions</b> .....	12
<b>2.2.2 Port Introduction</b> .....	13
2.3 Label Description .....	14
2.4 Introduction to Typical Networking .....	15
<b>Chapter 3 Site Selection Requirements</b> .....	<b>18</b>
<b>Chapter 4 Equipment Installation and Wiring</b> .....	<b>21</b>
<b>Chapter 5 System Operation</b> .....	<b>22</b>
5.1 Working Mode .....	22
5.2 LED Indicator State .....	24
5.3 mySigen App Query .....	26
<b>Chapter 6 System Maintenance</b> .....	<b>27</b>
6.1 Routine Maintenance .....	27
6.2 Equipment Powering-on/Power-off .....	28
6.3 Low SOC .....	30
6.4 Emergency Treatment .....	31
<b>Chapter 7 Appendix</b> .....	<b>33</b>
7.1 Technical Parameter .....	33

## Revision History

Version	Date	Description
01	2023.07.31	First official release.

# Overview

## Introduction



This document mainly introduces the product introduction, networking, system operation and maintenance of the devices in the SigenStor Home single-phase system.

## Readers

This document is suitable for product users and professionals

## Sign Definition

The following signs may be used in the document to indicate security precautions or key information. Before installation and operation, familiarize yourself with signs and their definitions.

Signs	Definition
 <b>Danger</b>	Danger. Failure to comply may result in death or serious personal injury.
 <b>Warning</b>	Danger. Failure to comply may result in serious personal injury or property damage.
 <b>Caution</b>	Caution. Failure to comply will result in property damage.
<b>Tips</b>	Important or key information, and supplementary operation tips.

# Chapter 1 Safety Precautions

## Basic Information

Before installing, operating, and maintaining the equipment, familiarize yourself with this document.

The "Danger", "Warning", "Caution" items described in this manual are only supplementary to all precautions.

The Company shall not be liable for equipment damage or property loss caused by the following reasons:

- Failure to obtain approval from the national, regional power authority.
- The installation environment does not meet international, national, or regional standards.
- Failure to observe local laws, regulations and norms when operating and maintaining equipment.
- The installation area does not meet the requirements of the equipment.
- Failure to follow the instructions and precautions in this document.
- Failure to follow the warning labels on equipment or tools.
- Negligent, improper operation or intentional damage.
- Battery capacity loss or irreversible damage caused by your failure to charge the device in time.
- Damage caused by your or a third party's replacement of our equipment (such as mixing our battery pack with other batteries, using our battery pack with other brands of inverters or converters, etc.).
- The equipment is damaged by your or the third-party company to use the accessories supplied with the package and purchase and use the accessories of the same specifications for installation.
- Equipment damage caused by improper operations such as disassembling, replacing, or modifying the software code without authorization.

- Equipment damage caused by force majeure (such as war, earthquake, fire, storm, lightning, flood, debris flow, etc.).
- Damage caused by the failure of the natural environment or external power parameters to meet the standard requirements of the equipment during actual operation (for example, the actual operating temperature of the equipment is too high or too low).
- The equipment was stolen.
- The equipment is damaged after the warranty period.

## Safety Requirements

### Danger

- The overheated battery pack may cause fire or explosion. Do not expose the device to high temperature or heat sources (such as sunlight, fire, or heaters) around the equipment for a long time.
- Do not clean or soak the equipment with water, alcohol, or oil to avoid power leakage or battery pack leakage.
- Do not knock or impact the equipment. In case of an accident, please stop using the equipment immediately and contact your sales agent, The equipment shall be inspected and evaluated by professional personnel before continuing to use.

### Warning

- Do not touch the heat sink when the equipment is running.
- When the equipment is running, do not cover the decorative cover plate and keep the heat dissipation channel of 300-600 mm to avoid fire at high temperature.

 **Caution**

- Do not use the equipment with faults. If the equipment appears abnormal (for example, battery pack leakage or appearance distortion), contact your sales agent.
- Carbon dioxide fire extinguishers and ABC dry powder fire extinguishers are recommended at home.
- If the equipment cannot be charged, please contact your sales agent in time.

**Do not use the equipment in the following situations:**

- When connected to public infrastructure systems.
- When connected to emergency medical equipment.
- When connected to elevators and other control devices.
- Any other critical systems.



# Chapter 2 Introduction to energy storage system

## 2.1 Product Introduction

### Inverter

Product code	Model No.	Name	Function specification
SigenStor EC	SigenStor EC 3.0 SP	Sigen Energy Controller 3.0 kW Single Phase	Inverter; it can be used in photovoltaic energy storage scenarios and needs to be used together with PV modules and SigenStor BAT.
	SigenStor EC 3.6 SP	Sigen Energy Controller 3.6 kW Single Phase	
	SigenStor EC 4.0 SP	Sigen Energy Controller 4.0 kW Single Phase	
	SigenStor EC 4.6 SP	Sigen Energy Controller 4.6 kW Single Phase	
	SigenStor EC 5.0 SP	Sigen Energy Controller 5.0 kW Single Phase	
	SigenStor EC 6.0 SP	Sigen Energy Controller 6.0 kW Single Phase	
SigenStor AC	SigenStor AC 3.0 SP	Sigen Storage Controller 3.0 kW Single Phase	Inverter; it can be used in pure storage scenarios and needs to be used with SigenStor BAT.
	SigenStor AC 3.6 SP	Sigen Storage Controller 3.6 kW Single Phase	
	SigenStor AC 4.0 SP	Sigen Storage Controller 4.0 kW Single Phase	
	SigenStor AC 4.6 SP	Sigen Storage Controller 4.6 kW Single Phase	
	SigenStor AC 5.0 SP	Sigen Storage Controller 5.0 kW Single Phase	
	SigenStor AC 6.0 SP	Sigen Storage Controller 6.0 kW Single Phase	

Sigen Hybrid	Sigen Hybrid 3.0 SP	Sigen Hybrid Inverter 3.0 kW Single Phase	Inverter; it can be used in conjunction with PV modules for pure PV applications or in combination with PV modules and SigenStor BAT for photovoltaic storage systems after the purchase and activation of a license.
	Sigen Hybrid 3.6 SP	Sigen Hybrid Inverter 3.6 kW Single Phase	
	Sigen Hybrid 4.0 SP	Sigen Hybrid Inverter 4.0 kW Single Phase	
	Sigen Hybrid 4.6 SP	Sigen Hybrid Inverter 4.6 kW Single Phase	
	Sigen Hybrid 5.0 SP	Sigen Hybrid Inverter 5.0 kW Single Phase	
	Sigen Hybrid 6.0 SP	Sigen Hybrid Inverter 6.0 kW Single Phase	

### Battery Pack

Product code	Model No.	Name	Function specification
SigenStor BAT	SigenStor BAT 5.0	Sigen Battery 5 kWh	It can store electric energy.
	SigenStor BAT 8.0	Sigen Battery 8 kWh	

### Power Sensor

Product code	Model No.	Name	Function specification
Power Sensor	Sigen Sensor SP-DH (SDM230MODBUS)	Sigen Power Sensor Single Phase DH	Data acquisition for grid connection points enables zero-power grid connection.
	Sigen Sensor SP-CT-DH (SDM120CTM)	Sigen Power Sensor Single Phase External CT DH	

## Communication Module

Product code	Model No.	Name	Function specification
CommMod	Sigen CommMod	Sigen Communication Module	If it's used with our inverters, the communication between inverters and management systems should be realized through 4G.

## 2.2 Appearance Introduction

### 2.2.1 Appearance and Dimensions

#### Inverter and Battery Pack

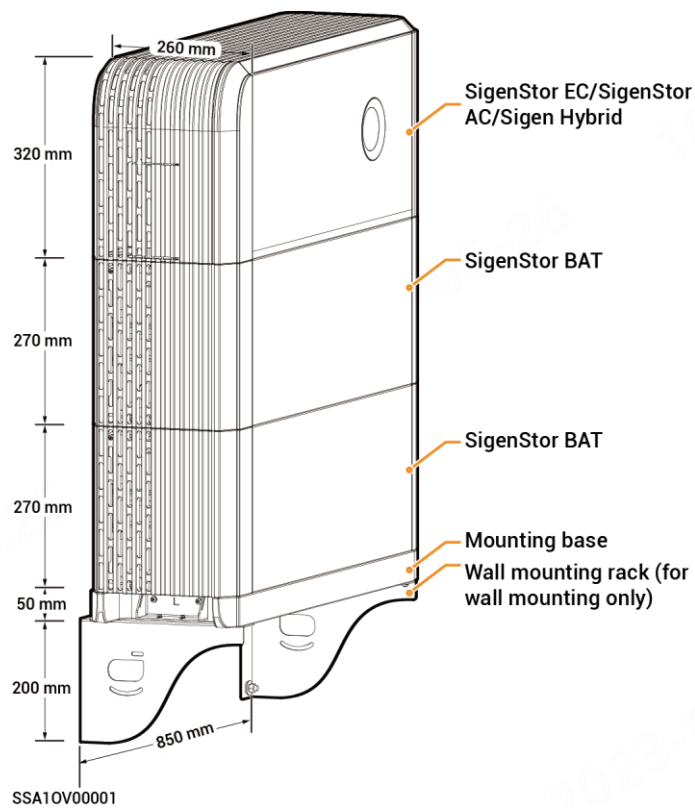

#### CommMod

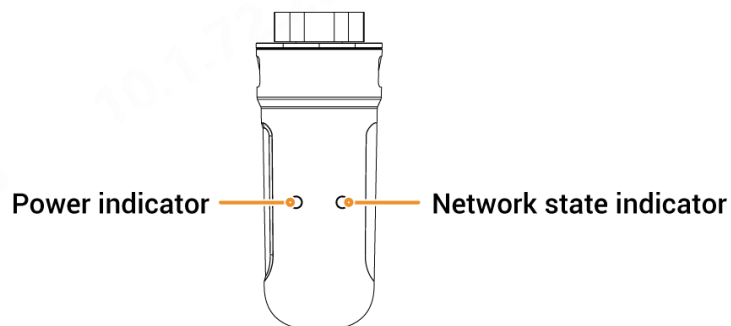

## 2.2.2 Port Introduction



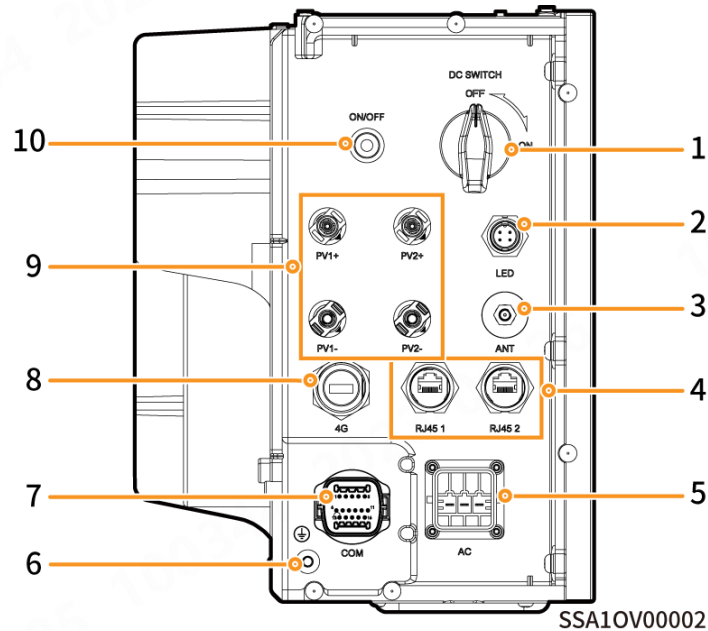

### SigenStor EC/ SigenStor AC/Sigen Hybrid Left View



SSA10V00002

S/N	Name	Marking
1	Dc switch	DC SWITCH
2	Decorative cover light strip connector	LED
3	Antenna interface	ANT
4	Cable interface	RJ45 1/ RJ45 2
5	AC output interface	AC
6	Ground screw	-
7	Communication interface	COM
8	Sigen CommMod interface	4G
9	DC input interface	PV1+/PV2+/ PV1-/PV2-
10	Switch button	ON/OFF

## 2.3 Label Description

Symbols	Definition
	<p>Warning! Life at risk.</p> <p>The equipment has potential hazards after running. Take proper protection when operating the equipment.</p>
	<p>After the equipment is powered off, the discharge of internal components is delayed. Wait 10 minutes until the equipment is fully discharged according to the label time.</p>
	<p>Warning! Risk of burns.</p> <p>The equipment surface is hot. Do not touch the inverter when it is running. Doing so may result in burns.</p>
	<p>Please refer to the instructions to operate the equipment.</p>
	<p>Earthing mark</p>

## 2.4 Introduction to Typical Networking

- The SigenStor Home energy storage system consists of photovoltaic panels, inverters, battery packs, master control switches, loads, power grids, etc.
- The main function of SigenStor Home energy storage system is to store the direct current generated by photovoltaic panels into battery packs. Or alternatively, the electricity in the photovoltaic system and the battery pack can be converted into alternating current for use by the load or incorporated into the grid.

### Networking Diagram (Backup Networking)

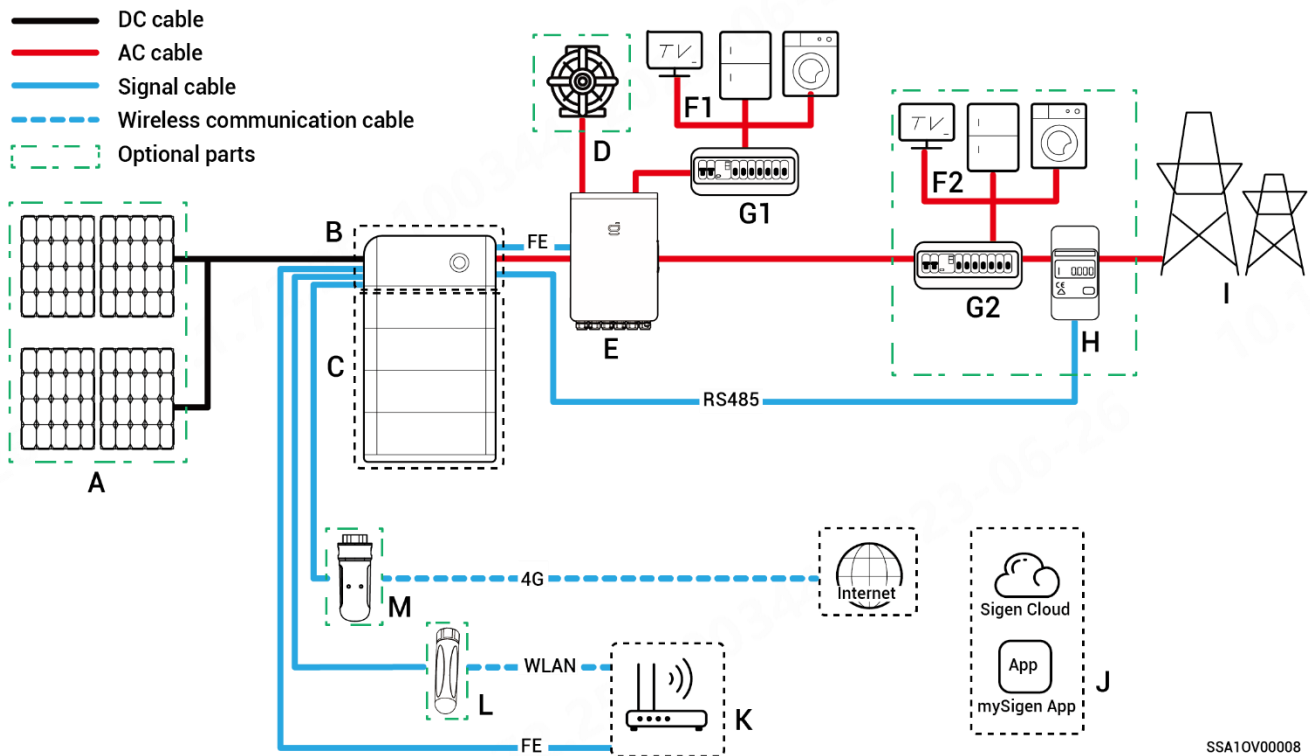

SSA10V00008

- |           |                               |           |   |
|-----------|-------------------------------|-----------|---|
| <b>A</b>  | PV panel                      | <b>B</b>  | SigenStor EC/ SigenStor AC/Sigen Hybrid |
| <b>C</b>  | SigenStor BAT                 | <b>D</b>  | Diesel generator                        |
| <b>E</b>  | Gateway                       | <b>F1</b> | Backup electric equipment               |
| <b>F2</b> | Non-backup electric equipment | <b>G1</b> | Backup distribution panel               |
| <b>G2</b> | Non-backup distribution panel | <b>H</b>  | Power Sensor                            |
| <b>I</b>  | Power Grid                    |           |   |

## Tips

- When B is SigenStor AC, A is not configured.
- In case of home-wide backup, F2, G2, and H are not configured; for partial backup, H can be left un-configured; in case of partial backup + zero-power grid connection control, F2, G2, and H are configured.
- As a backup energy source for long-term off-grid applications, the diesel generator can work in tandem with the Gateway to provide a smooth transition between PV, storage and diesel power generation.
- It is recommended to use FE and WLAN for communication with inverter. CommMod users must top up their own 4G data plan after a period of 2 years.

## Networking Diagram (Non-backup Networking)

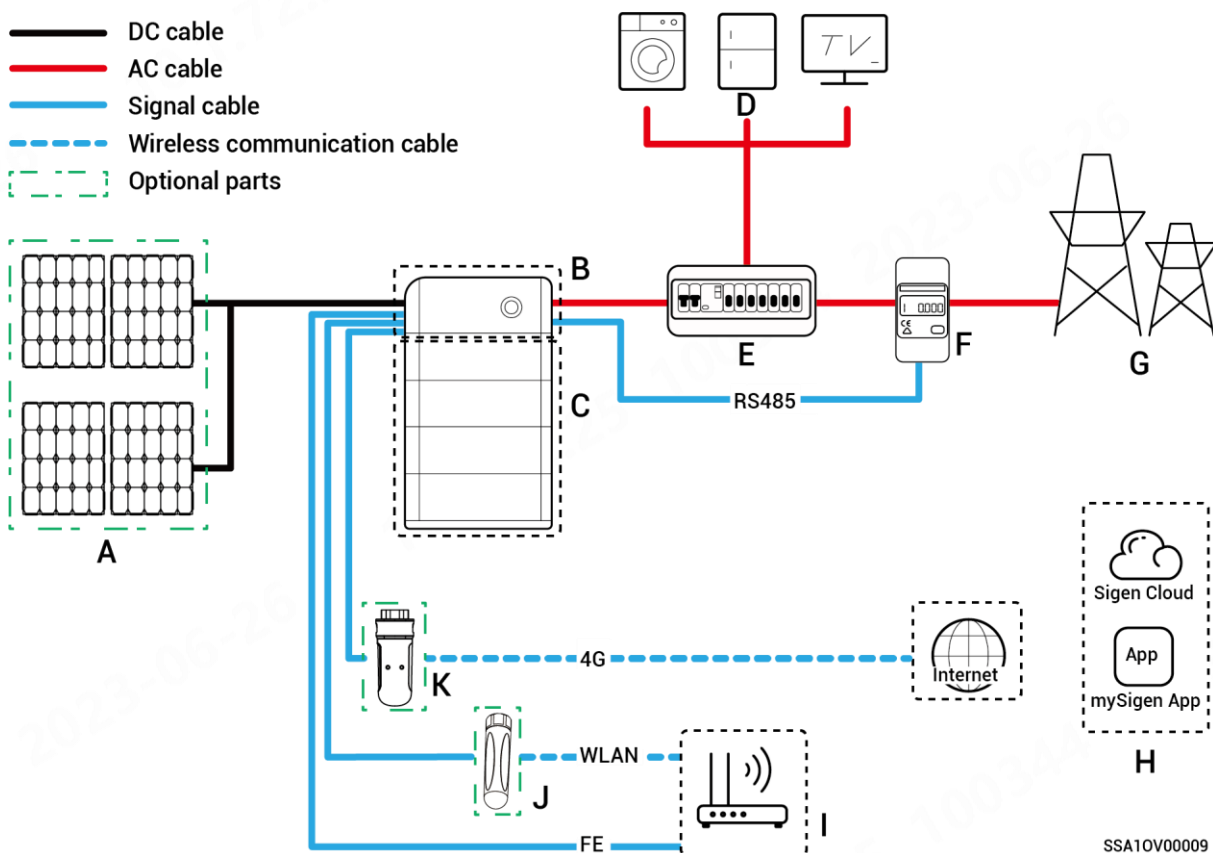



<b>A</b>	PV panel	<b>B</b>	SigenStor EC/ SigenStor AC/Sigen Hybrid
<b>C</b>	SigenStor BAT	<b>D</b>	Electric
<b>E</b>	Distribution panel	<b>F</b>	Power sensor
<b>G</b>	Power grid	<b>H</b>	mySigen
<b>I</b>	Router	<b>J</b>	Antenna
<b>K</b>	CommMod		

## Tips

- When B is SigenStor AC, A is not configured.
- When B is Sigen Hybrid, A is optional.
- It is recommended to use FE and WLAN for communication with inverter. CommMod users must top up their own 4G data plan after a period of 2 years.
- The rated voltage of the AC switch connected to each inverter should be  $\geq$  240 V AC and the rated current is recommended:
  - SigenStor EC/SigenStor AC/Sigen Hybrid (3.0-4.0) SP: The rated current is 25 A
  - SigenStor EC/SigenStor AC/Sigen Hybrid (4.6-6.0) SP: The rated current is 40 A

# Chapter 3 Site Selection

## Requirements

### Installation Environment Requirements

- Do not install the equipment in smoky, flammable, explosive, or corrosive environments.
- Do not install the equipment outdoors in areas prone to salt damage area, which are located less than 500 meters from the coastline or affected by sea wind.
- Do not install the equipment in environments exposed to direct sunlight, rain, standing water, snow accumulation, sand, and dust. It is recommended to install in a sheltered location. If the area is susceptible to natural disasters such as floods, landslides, earthquakes, or typhoons, take preventive measures during equipment installation.
- Do not install the equipment in environments with electromagnetic interference.
- Ensure that the temperature and humidity of the installation environment comply with the equipment's requirements.

### Installation Position Requirements

- Do not tilt or overturn the equipment to ensure that it is installed horizontally.
- Do not install the equipment in a place where children can easily reach it.
- Do not install the equipment in areas subject to fire or moisture (including but not limited to kitchen, tea room, toilet, shower room, laundry room, etc.).
- Please keep away from daily working and living areas (including but not limited to living room, bedroom, studio, lounge, study, etc.).
- Do not install the equipment in areas that are difficult to access (including but not limited to attic, basement, etc.).

- Do not install the equipment in mobile scenarios such as RVS, cruise ships, and trains.
- You are advised to install the equipment in a position that is easy to operate, maintain, and view indicator status.
- When installing the equipment in the garage, do not install the equipment in the position where the vehicle passes through to avoid collision.

## **Mounting Surface Requirements**

- Do not install the equipment on a flammable carrier.
- The installation carrier must meet load-bearing requirements. Solid brick-concrete structure, concrete walls, and ground are recommended.
- The surface of the installation carrier must be smooth and the installation area must meet the installation space requirements.
- No water or electricity is routed inside the carrier to prevent drilling hazards during equipment installation.

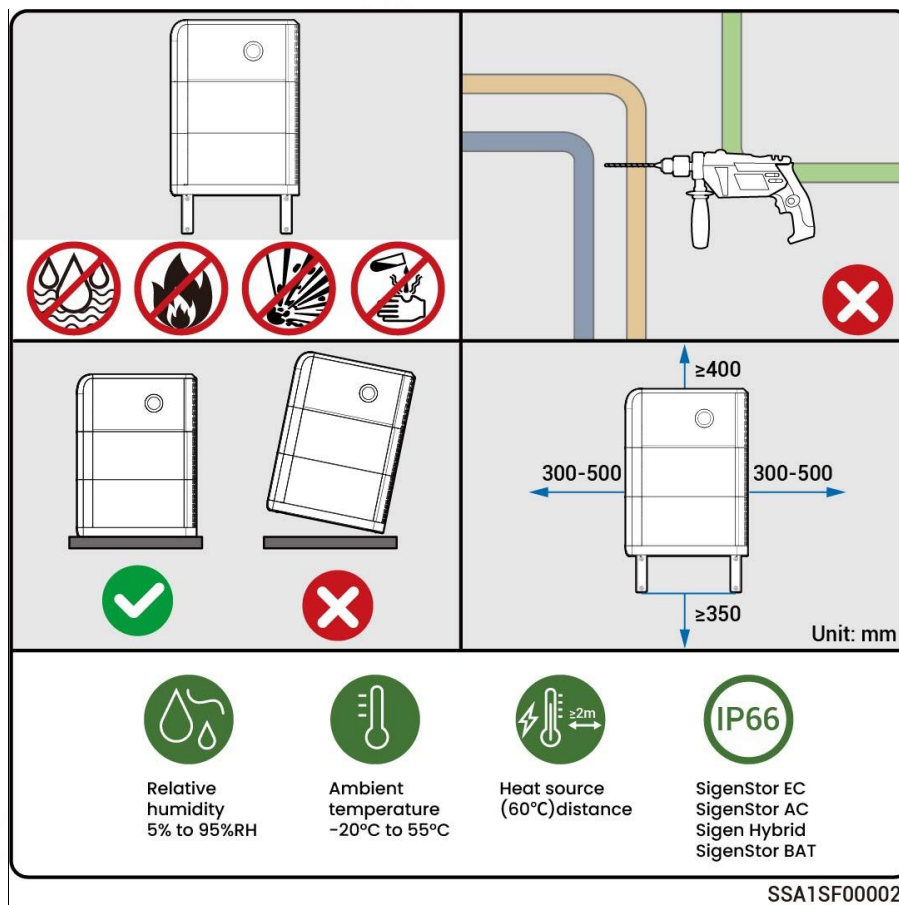

## Tips

- The maximum operating temperature range applicable to the equipment is  $-20^{\circ}\text{C}$  to  $55^{\circ}\text{C}$ , and the recommended optimal operating temperature range is  $10^{\circ}\text{C} < T < 35^{\circ}\text{C}$ .
- When the battery pack temperature is below  $0^{\circ}\text{C}$ , immediate charging is not possible, and the battery pack (the built-in heating module can be automatically enabled) will activate the heating feature automatically. The best charging performance of the battery can be achieved after heating for less than 2 h. The heating feature will consume power.
- At a temperature  $> 40^{\circ}\text{C}$ , the operation of the equipment may trigger a power derating that prevents the equipment from operating optimally. The higher the temperature, the shorter the service life of the equipment.

# Chapter 4 Equipment

## Installation and Wiring

Only company authorized personnel should install and connect the equipment.

For details, see ***SigenStor Home Installation Guide - Single-phase System A1***.

# Chapter 5 System Operation

## 5.1 Working Mode

There are two operating modes of the energy storage system: Sigen AI Mode; Self-Consumption Mode.

### Sigen AI Mode

By recording the peaks and troughs of users' consumption habits and local electricity prices for a period of time, Sigen AI mode can customize smart electricity solutions to maximize savings for customers.

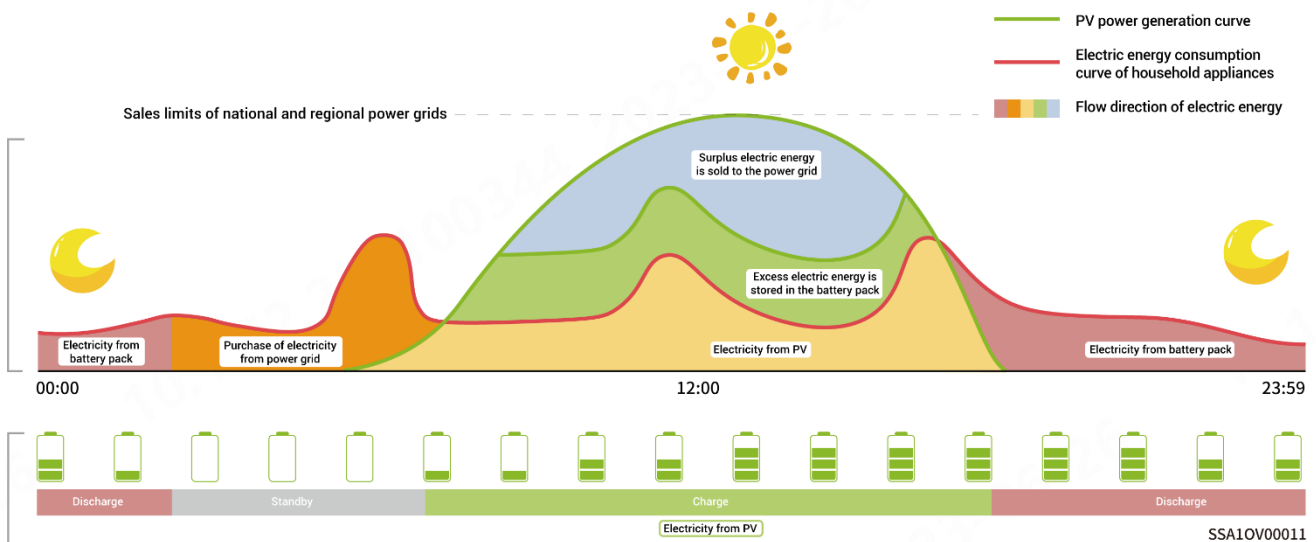

### Self-Consumption Mode

The excess photovoltaic power output is stored in the battery. When the photovoltaic power generation is insufficient or there is no photovoltaic power generation at night, electric energy is released from the battery for load operation, so as to improve the percentage of electricity generated for in-house use and the self-sufficiency rate of household energy, thus saving electricity costs.

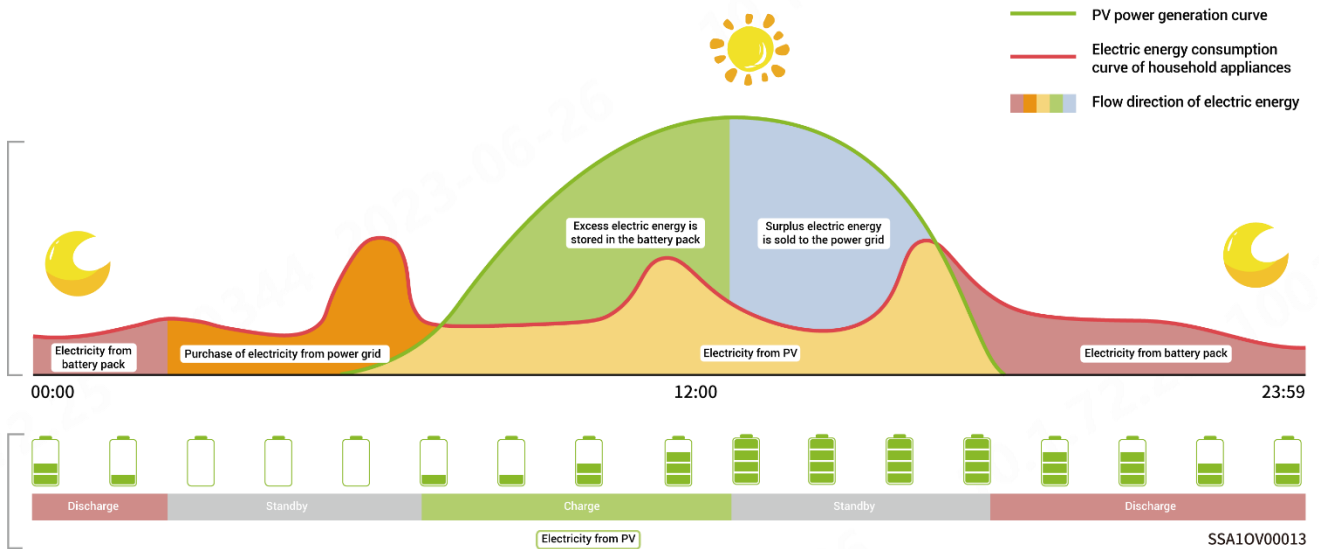

## Backup Reserve

If there is a Gateway in the network, you can manually set the "Backup Reserve" value in mySigen App. When the grid is connected, the battery stops discharging when the set backup SOC is reached; when the grid is powered down, the battery power from the backup can be used.

Example: Self-Consumption Mode involves backup SOC.

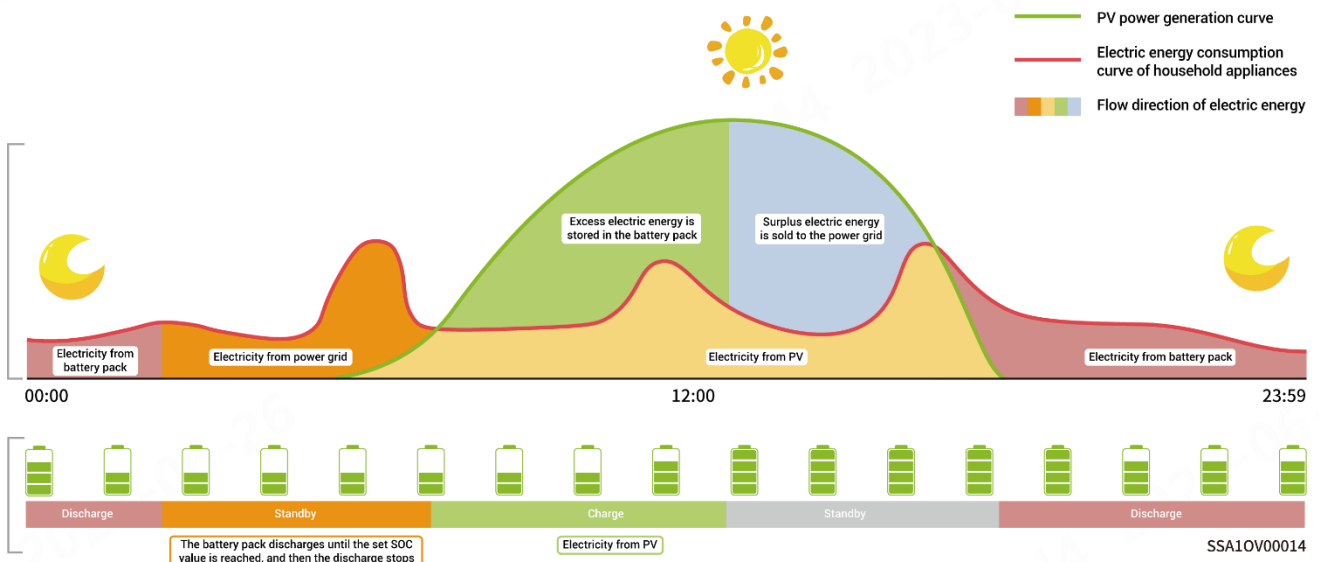

## 5.2 LED Indicator State



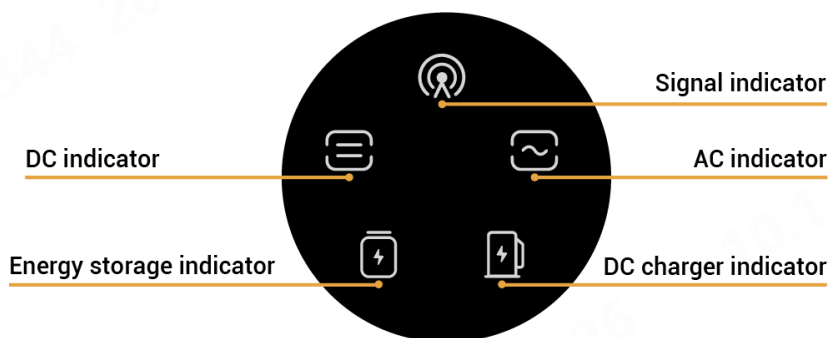





### SigenStor EC/ SigenStor AC/Sigen Hybrid Indicator



SSA1IN00027

Indicator	Color	State	Description
		Always on	The DC side is connected but not running.
		Always on	The DC side is running.
		-	The DC side is not connected.
		Flash	The DC side is faulty.
		Always on	Inverter failure.
		Always on	The AC side is connected but not running.
		Always on	Grid-connected operation.
		Always on	Off-grid operation.
		-	The AC side is not connected.
		Flash	Off-grid overload operation.
		Flash	The AC side is faulty.
		Always on	Inverter failure.
		Always on	All SigenStor BATs are connected but not running.
		Flash	SigenStor BAT is charging.
		Flash	SigenStor BAT is discharging.



Indicator	Color	State	Description
		-	All SigenStor bats lie dormant.
		Flash	Some SigenStor BATs are faulty.
		Always on	All SigenStor bats are faulty.
		Off	The management system is not connected.
		Flash	Connected to local App.
		Always on	Connected to the management system using an FE or WLAN.
		Always on	Connected to the management system over 4G.

## CommMod Indicator

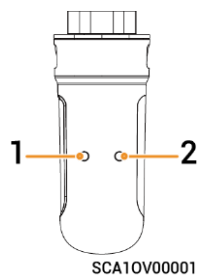

S/N	Name	State	Description
1	Power indicator	-	-
2	Network state indicator	Slow flashing (200 ms on/1800 ms off)	The network is being connected
		Slow flashing (1800 ms on/200 ms off)	Standby.
		Quick flashing (125 ms on/125 ms off)	Data is being transferred.

## 5.3 mySigen App Query

The App can be downloaded in the following two ways. For details, see *mySigen App User Manual*.

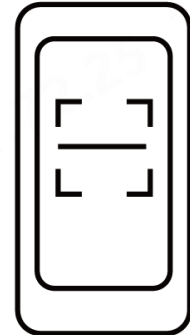

SSA1CM00014

# Chapter 6 System Maintenance

## 6.1 Routine Maintenance

To ensure the long-term running of the equipment, you are advised to perform routine maintenance according to this section.

<b>Inspection content</b>	<b>Inspection method</b>	<b>Power off or not</b>	<b>Maintenance cycle</b>
System cleaning	Check the decorative cover regularly for shielding and dirt. If so, clean it up. Do not use tools that may cause electric shock or insulation damage, such as wire brushes and wet towels during the cleaning process.	Yes	Once every three months.
System running state	<ul style="list-style-type: none"> <li>● Check whether the equipment is damaged or deformed.</li> <li>● Listen for any abnormal noises during the operation of the equipment.</li> <li>● When the equipment is running, check whether the equipment parameters are correctly set.</li> </ul>	No	Once every six months.

## 6.2 Equipment Powering-on/Power-off

### Scheme 1: App operation

Tap "Setting" in mySigen APP to turn on/off the device.

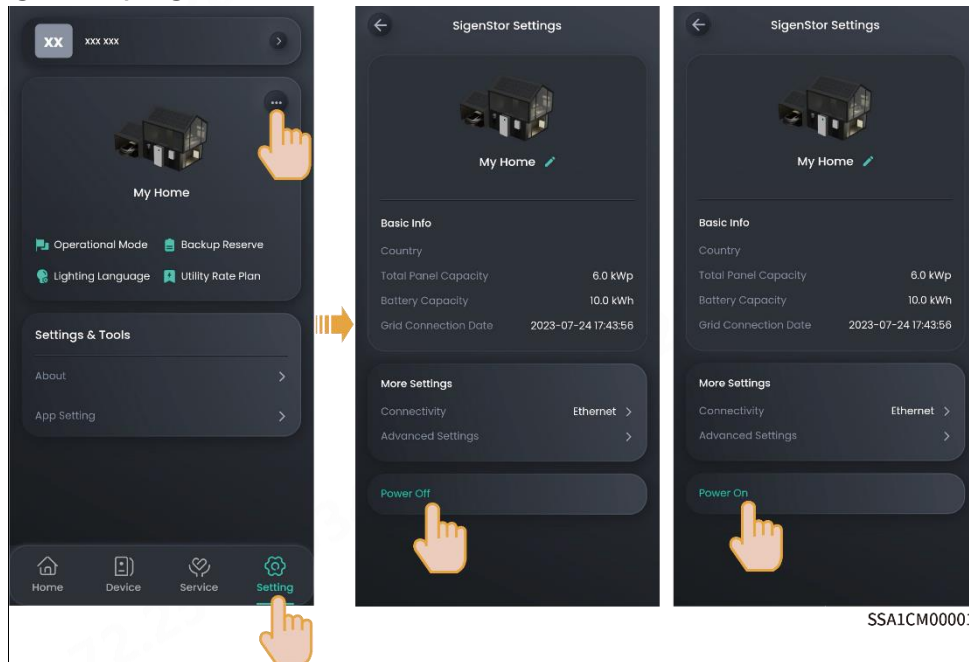

### Scheme 2: Manual operation

Follow the steps shown to remove the side and top decorative cover, and press the ON/OFF switch button.

#### Tips

Press and hold for more than 3s to turn on or off the power; an interval of more than 10s is needed between power-on and power-off.

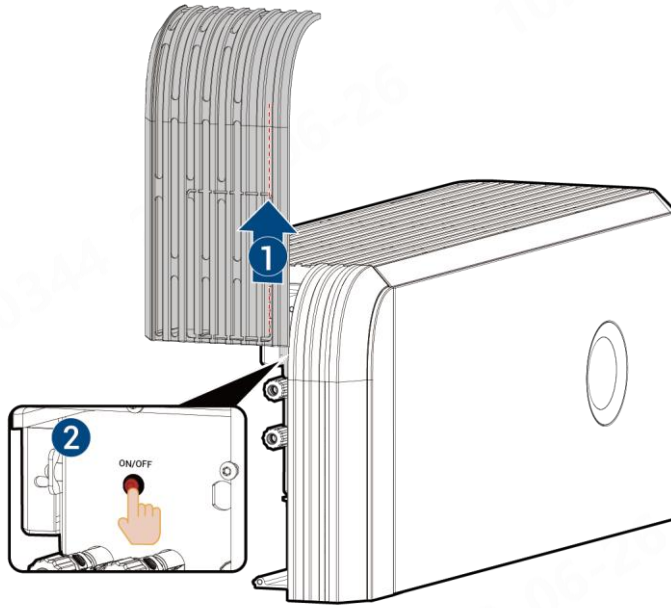

SSA1IN0030

## 6.3 Low SOC

The self-discharge characteristic of battery pack will cause power loss. If the equipment is not charged for a long time, it may be damaged due to overdischarge of power. When the battery is low, charge the equipment in time. Under normal circumstances, the equipment can charge itself according to the running condition. If the equipment cannot be charged, please contact your sales agent in time and deal with it within the specified time. If the battery capacity is lost or irreversible damage is caused due to the delay, the company will not be liable.

- When the battery power is more than 10% (inclusive), charge within 30 days
- When the battery power is more than 0 (inclusive) and less than 5%, charge within 7 days

Scenarios that may cause a charge failure (including but not limited to) :

- The PV side has no input, and the power grid side is powered off for a long time.
- The equipment is faulty.
- Parameters are not set correctly.

## 6.4 Emergency Treatment

### Emergency Measures for Fire

#### Danger

- Please shut down the equipment or disconnect the main power switch when it is safe.
- The high temperature may distort or damage the battery pack, resulting in electrolyte overflow or toxic gas leakage. Do not go near the battery pack and wear protective equipment.
- If the fire is small, use carbon dioxide or ABC dry powder extinguisher to extinguish the fire.
- If the fire is spreading, evacuate the building or equipment area immediately and call the fire department. Re-entry to burning buildings is prohibited.
- Do not contact with high voltage components during fire fighting, otherwise it may lead to the risk of electric shock.
- After extinguishing the fire, do not use the equipment, please contact your sales agent.

### Emergency Measures for Flood

#### Danger

- Please shut down the equipment or disconnect the main power switch when it is safe.
- If the battery pack is submerged, do not touch it to avoid the danger of electric shock.
- After the flood waters recede, do not use the equipment. Please contact your sales agent.

## Emergency Measures for Battery Pack Exceptions

### **Danger**

- When the battery pack has abnormal odor, electrolyte leakage, or heat, do not touch it, and contact professional personnel immediately. Professionals must wear protective equipment such as goggles, rubber gloves, gas masks, and protective clothing to protect themselves.
- The electrolyte is corrosive and contact may cause skin irritation or chemical burns. In case of accidental contact with electrolyte, take the following measures immediately:
  - Inhalation: Evacuate the contaminated area, keep fresh air circulating, and seek immediate medical help.
  - Eye contact: Flush eyes with plenty of water for at least 15 minutes. Do not rub eyes. Seek medical help immediately.
  - Skin contact: Wash the contact area with plenty of soapy water and seek medical help immediately.
  - Ingestion: Induce vomiting and seek medical help immediately.
- Do not continue to use abnormal battery packs, please contact your sales agent.

## Emergency Measures for Battery Pack Drops or Impacts

- If there is an obvious odor, smoke, or fire, keep away from the equipment immediately and contact professional personnel.
- Do not use the battery pack if it has been dropped or hit. Please contact your sales agent.



# Chapter 7 Appendix

## 7.1 Technical Parameter

For details about equipment parameters, see the Data sheets of the product.