

BF100 USER MANUAL

EnerCore
Outdoor Air-cooling
Battery Cabinet

Content

Statement of Law	1
Revised History	1
1. Guideline	2
1.1. Use of Manuals	2
1.2. Symbol and Abbreviation	2
2. Safety Instructions	4
2.1. Safety Principle	4
2.2. Operator Qualifications	4
2.3. Environmental Safety Requirements	5
2.4. Electrical Safety Requirements	5
2.5. Transportation and Installation Safety Requirements	6
2.6. Daily Operation and Maintenance	6
2.7. Product Obsolescence	7
3. Product Description	8
3.1. Product Overview	8
3.2. Product Model	8
3.3. Product Configuration	8
3.4. System Parameters	9
3.5. Appearance Design	11
3.6. Internal Design	13
3.7. Main Modules	13
4. Transportation and Storage	18
4.1. Unpacking and Checking	18
4.2. Lifting Transportation	18
4.3. Forklift Transportation	19
4.4. Storage Requirement	20
5. Installation	22
5.1. Installation Environmental Requirements	23
5.2. Installation Spatial Requirements	24
5.3. Installation Procedure	25
5.4. Fixed Installation	26
5.5. Preparation Before Installation	28
5.6. Checking Before Wiring	30
5.7. PE Wiring	31
5.8. Electrical Wiring	32
5.9. Communication Wiring	34
5.10. Checking After Wiring	35
6. Power On and Power Off	37
6.1. Power On Process	37

6.2.	Power Off Process	38
6.3.	Emergency Stop	38
7.	HMI Operation	40
7.1.	Operation System Overview	40
7.2.	User Login	41
7.3.	Running Information	43
7.4.	Query Data	45
7.5.	EMS Setting	45
8.	Fault Description	49
9.	System Maintenance	51
10.	Quality Assurance	54
11.	Appendix	55

Statement of Law

The copyright of this document belongs to Dyness Digital Energy Technology Co., LTD.

(the following will be referred to as "Dyness").

No part of this document may be excerpted, translated, annotated or reproduced in any form or by any means without the prior written authorization of Dyness.

It is prohibited to use part or all of the data in the firmware or software developed by the Company for commercial purposes in any way.

It is prohibited to decompile, decrypt or otherwise damage the original program design of the software developed by the Company.

This product complies with the design requirements for environmental protection and personal safety. The storage, use and disposal of the product shall be in accordance with the product manual, relevant contract or relevant laws and regulations.

When products or technologies are updated, customers can check the information on the website of Dyness.

Website: <http://www.dyness.com/>

Please note that products can be modified without prior notice.

Revised History

Revised Version	Revision Date	Revision Reason
1.0	2024.09	First publication

1. Guideline

CAUTION: Read this manual carefully before installing or operating this product. Keep this manual in a safe place for future reference.

1.1. Use of Manuals

- Manual content: this manual mainly introduces the safety precautions, functions and specifications, delivery and storage, installation and wiring, power on/off process, HMI operation, maintenance and quality assurance of this ESS product.
- Applicable population: this manual is suitable for professional technicians who install and maintain the ESS product, as well as users who carry out daily operation. Readers should have certain electrical knowledge.

1.2. Symbol and Abbreviation

This manual may contain the following symbols to emphasize important information, to ensure the safety of the user's personal and property when installing this product, or to facilitate the efficient operation, please read it carefully.

Table 1-1 Symbol Mark

	Indicate that there is high voltage inside the ESS cabinet, so beware of electrocution resulting in personal safety issues
	Indicate an electrical hazard, all external power connections must be disconnected before maintenance and operation
	Anti-temperature mark
	Ventilation mark
	Indicate that there is protective earthing (PE) terminal, which is used to prevent electric shock in the event of a fault, and needs to be firmly earthed to ensure operator safety
	Recycle mark
	Hazardous waste, need professional recycling, can not be put into the trash can
	Instruction (User manual) mark

References to the following products in this manual are replaced by abbreviations for ease of presentation.

Table 1-2 Abbreviation Definition

Abbreviation	Full name
ESS	Energy Storage System
EMS	Energy Management System
BMS	Battery Management System
PACK	Battery Module
BDU	Battery Distribution Unit
SOC	State of Charge
SOH	State of Health
DC	Direct Current
AC	Alternating Current
CT	Current Transformer
PE	Protective Earthing

2. Safety Instructions

2.1. Safety Principle

Related safety precautions need to be strictly followed during installation, operation and maintenance. This product is a combined high-voltage DC and three-phase AC system and should only be operated by Dyness authorized personnel.



DANGER

- Deadly high voltages are present inside the product, please observe and comply with the warning labels on the product;
- Do not touch the power grid or the contacts connected to it inside the product to prevent the risk of fatal electric shock!
- Damage to the battery may result in electrolyte leakage. If the electrolyte leaks, do not touch the leaking electrolyte or volatile gases and contact the after-sales service team immediately for assistance.



WARNING

- Transportation, installation, maintenance must comply with local regulations and this user manual;
- Installation work must be assigned to a specialized full-time operator.



PROHIBITION

- Risk of damage to the battery system or personal injury or behavior is prohibited;
- Replacement of the modules by the user is prohibited and the company will not be responsible for any damages caused.

2.2. Operator Qualifications

Only qualified electricians or professional personnel can operate the product, the operator should meet the following requirements.

- Shall be familiar with local standards and relevant electricity safety regulations;
- The operator shall have received professional training related to the installation and commissioning of electrical equipment, and should have the ability to respond to emergencies or unexpected situations that may occur during installation or trial operation.
- The operator shall have certain specialized knowledge of electronics, electrical wiring and machinery, and be familiar with electrical and mechanical schematic diagrams;
- The Operator should be fully familiar with equipment protection and standard maintenance, and operations should comply with established safety standards.

2.3. Environmental Safety Requirements

- Do not install and use the product in environments with temperature below -20°C or above 50°C;
- Do not install and use the product near any heat sources or combustible materials;
- Do not install and use the product in areas with frequent movement of personnel;
- Do not expose the product to corrosive gases or liquids;
- Keep the product installation and use away from children and animals;
- The maximum installation altitude for the product should not exceed 3000m, and it should be derated when above 2000m;
- Sufficient space should be reserved for product installation to ensure adequate ventilation;
- Isolation barriers must be set up during installation to prevent any unrelated personnel from entering the site.

2.4. Electrical Safety Requirements

The operator must ensure that: all basic information and step-by-step instructions are understood before commissioning and switching off the disconnecting circuit-breaker.



DANGER

Battery Protection Safety

Please ensure that during installation, maintenance of the equipment:

- The battery is completely disconnected;
- Have a visible warning sign at the break point to ensure no accidental reconnections.

Ground Fault Protective Safety

- When a ground fault occurs, the original non-electrified part may carry high voltage, and accidental electric shock can lead to personal safety! Ensure that there is no ground fault and take necessary protective measures before operation.

Safety Of Live Line Measurements

- Given the presence of high voltages in this equipment, protective measures (e.g., wear insulated gloves, etc.) must be taken during live line measurements, and the operator must be accompanied by a person to ensure personal safety.

Arc Protection Safety

- Avoid arc, fire and explosion hazards caused by improper operation;
- Prohibit touching uninsulated cables that may be energized;
- When a loose connection occurs in the power cable, or a screw or other component falls out accidentally, do not operate it without authorization, and it must be handled by a qualified professional to avoid causing a larger malfunction.

2.5. Transportation and Installation Safety Requirements



WARNING

Personnel Operation Regulations

- Forklifts, cranes and other construction machinery must be operated by qualified operators if required on site;
- The operator must wear insulated protective equipment that complies with safety regulations during installation;
- When connecting the power on-site, a professional guardian must be assigned to protect the switches that need to be turned off;
- Ensure that it has no electrical connections before installation;
- Each completed project must be checked at least once and cross-checked during the installation process;
- The equipment must be installed in sequence without skipping any steps.

Wiring regulations

- Appropriate measuring devices must be used, appropriate standards and directives must be followed;
- The operating manual of the measuring device must be known before any measurement is carried out;
- Only use equipment specified by Dyness. Failure to use equipment specified by Dyness may result in impaired protection as well as injury to personnel.

Test run after installation

- Only after confirmation by professionals and obtaining permission from local electrical authorities can the equipment be put into operation;
- Before operation, please switch off all distribution circuit breakers, and it is strictly prohibited to disconnect them during product running.



DANGER

- Do not change fuse size or rating value during installation;
- It is not allowed for two or more operators to connect a single wire simultaneously during the wiring process.

2.6. Daily Operation and Maintenance

All operations of the product should follow the instructions in the User Manual. Damage to the equipment caused by violation of these instructions will void the associated liability and warranty. If necessary, contact Dyness Customer Service for repairs.

**WARNING**

- The software, shell and components of the product may not be changed without Dyness authorization. If changed, the corresponding liability and warranty shall be void;
- Do not remove or alter the nameplate;
- Do not open the cabinet doors in inclement weather such as rain or strong winds.

2.7. Product Obsolescence

When the product as a whole or individual internal components become aged or damaged and need to be discarded, they cannot be disposed as regular waste. Some components inside the product can be recycled and reused. Improper disposal of certain components may cause environmental pollution.

Please contact qualified local professional recycling organization for proper disposal of the product and internal components.

3. Product Description

3.1. Product Overview

The product is an outdoor battery cabinet, including PACK, BDU (integrated BMS and EMS), fire protection system, air conditioning system and so on. With the hybrid inverter converted to AC output, it can be widely used in charging stations, commercial buildings, manufacturing and other small-scale industrial and commercial scenarios.

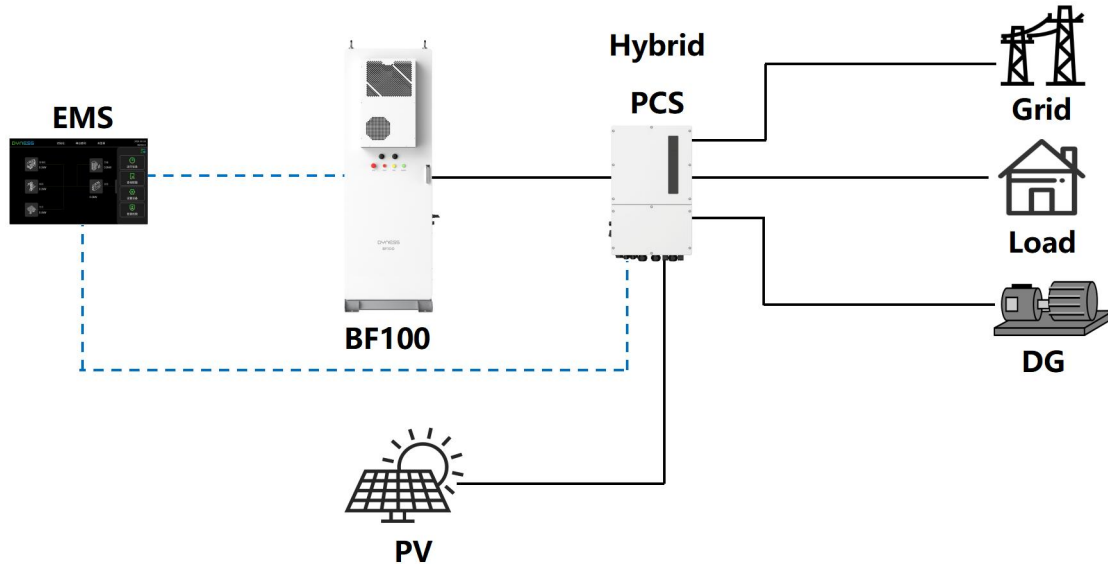

Figure 3-1 System Application Principle

3.2. Product Model

This manual applies to outdoor battery cabinet products (BF100) of Enercore series. The definition are explained as below:

- EnerCore: Product series name
- B: Battery, Dyness battery series product
- F: Fan/air-cooling system
- 100: Battery capacity of standard model
- C: Indicate system capacity, the number after "C" means the initial system capacity of different model, unit: kWh

Table 3-1 Product Model

No.	Model	Description
1	BF100-C70	Battery cabinet, Nominal capacity: 71kWh
2	BF100-C80	Battery cabinet, Nominal capacity: 86kWh
3	BF100-C100	Battery cabinet, Nominal capacity: 100kWh

3.3. Product Configuration

The product adopt modular design which is more convenient for installation, operation and maintenance

- 1) The product including PACK, BDU (integrated BMS and EMS), fire protection system, air conditioning system and so on;
- 2) The product is equipped with composite detector (incorporating smoke/ gas/ temperature detectors), water immersion detector, aerosol and other facilities, making the product safer;
- 3) The product is equipped with EMS, which could achieve effective and reliable energy management, enables remote monitoring and program upgrade through Ethernet, 4G and RS485 network access;
- 4) The product is equipped with breakers, fuses, contactors and other disconnect devices to achieve reliable power cutoff, ensuring personnel and equipment safety.

Table 3-2 Product Configuration List

Module	Function	Qty.	Config.
PACK	For electrical storage	5~7	Standard
BDU	BMS: Collect battery information and control battery charging and discharging	1	Standard
	EMS: Energy management and total control of the entire system		Standard
Fire protection system	Timely warning of battery thermal runaway and making correct instructions	1	Standard
Air conditioner system	Adjust battery working temperature to ensure it works under optimal temperature	1	Standard

3.4. System Parameters

BF100 parameters is shown as follows (The parameter may vary without notice during product upgrade):

Table 3-3 BF100 Parameter

Model	BF100-C70	BF100-C80	BF100-C100
Battery			
Battery Type	LFP (LiFePO4)		
Battery Capacity	280Ah		
Rated Current	140A		
Max. Current	160A		
PACK Configuration	1P16S		
PACK Quantity	5 PACK/Cluster	6 PACK/Cluster	7 PACK/Cluster
Voltage Range	232~288Vdc	278.4~345.6Vdc	324.8~403.2Vdc
Nominal Capacity	71kWh	86kWh	100kWh
System			
Weight	1100±100kg	1200±100kg	1300±100kg
Dimension (W*D*H)	725*1224*2258mm		

Max. Efficiency	≥94% (TBD)
Air Conditioner Power	2kW (Cooling), 1kW (Heating)
Temperature	-20~50°C (Derating above 45°C)
Humidity	0~95%RH (Non-condensing)
Ingress Protection	IP55
Anti-corrosion Grade	C3/C5
Cooling Method	Air-cooling
Noise	≤65dB (TBD)
Elevation	3000m (Derating above 2000m)
Display	Touch screen
Fire Protection	Aerosol/Perfluorohexanone
Communication	Ethernet/4G/RS485
Certification	CE

3.5. Appearance Design

- Dimension(W*D*H): 1200*1224*2258mm (Rings not included)
- Net weight: Approx 1300kg (Model BF100-C100 as reference)
- Ingress protection grade: IP55
- Anti-corrosion level: C3/C5 optional

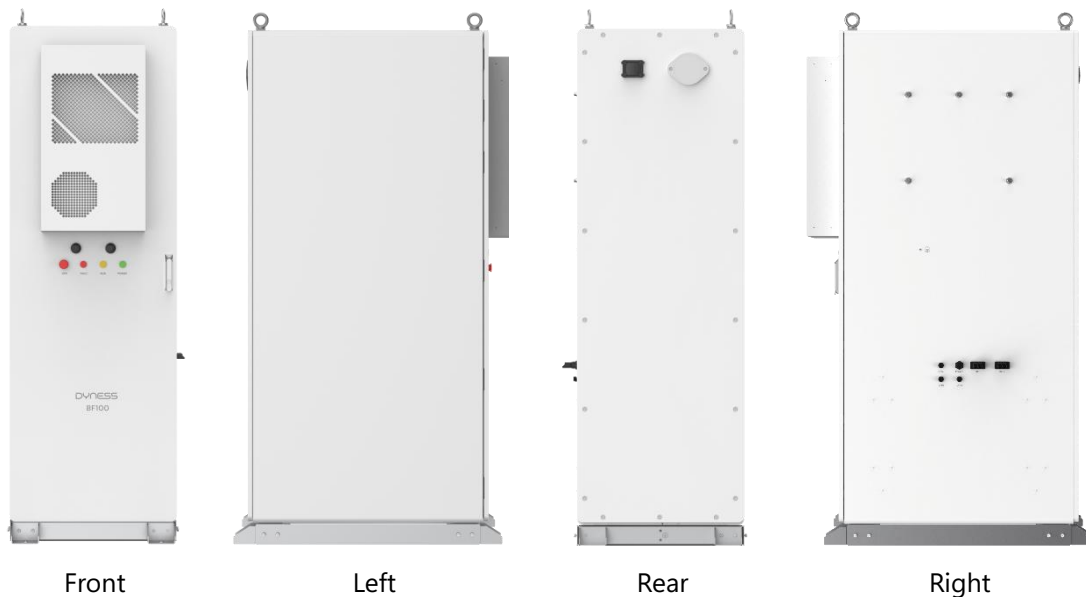

Figure 3-2 Product Appearance

The front panel of the product is equipped with 1 emergency stop button, 3 indicator lights showing the main operating status of the product, and 2 antennas:
Antennas from left to right: 4G, GPS;

Indicator lights from left to right: emergency stop button "EPO", alarm indicator "FAULT", running indicator "RUN" and power indicator "POWER".

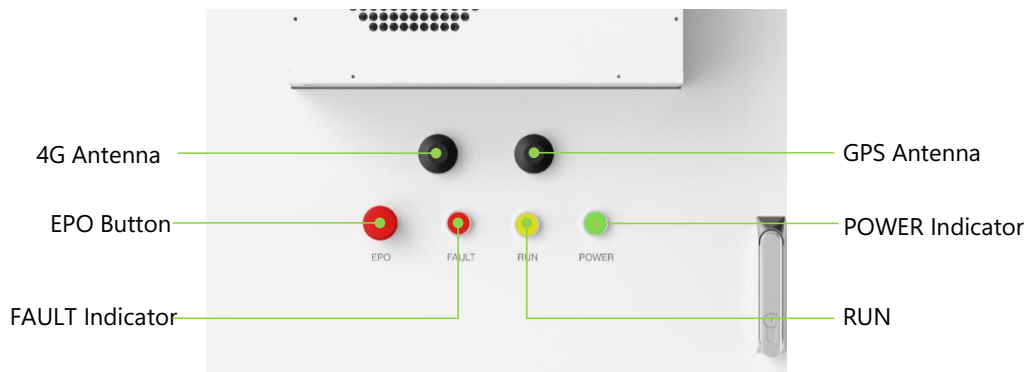

Figure 3-3 Product Indicators

Table 3-4 Indicator Name and Function

NO.	Color	Name	Function
1	●	EPO	The system stops when the button is pressed
2	●	FAULT	Light stay on indicates a system malfunction
3	●	RUN	Light stay on indicates normal system operation, off indicates standby
4	●	POWER	Light stay on indicates power is applied and ready for operation
5	●	4G	Receive and send 4G signals
6	●	GPS	Receive location signals

* CAUTION: Do not operate the emergency stop button in a non-emergency situation.

3.6. Internal Design

The product is an outdoor battery cabinet, including PACK, BDU (integrated BMS and EMS), fire protection system, air conditioning system, HMI screen.

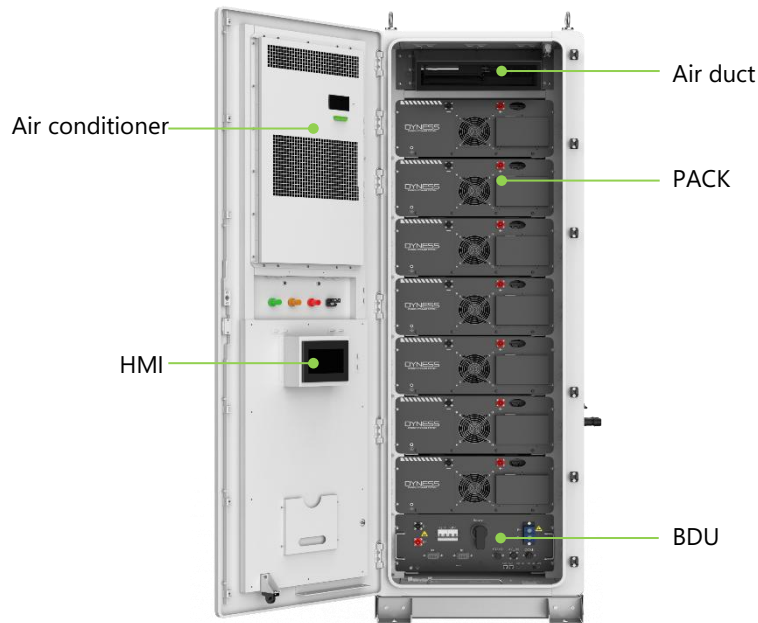

Figure 3-4 Internal Structure

3.7. Main Modules

3.7.1. PACK

The PACK adopts 280Ah LFP battery, which have excellent safety, high energy density;
 The PACK cell string: 1P16S; Capacity: 14.33kWh /PACK;
 The PACK adopts air-forced cooling method by fan;
 The PACK is equipped with IP20 grade, pollution-free modular assembly, high structural reliability and low maintenance cost.



Figure 3-5 PACK

Table 3-5 PACK Configuration

Model Number	HV51280F
String Form	1P16S

Battery Energy (kWh)	14.33
Nominal Voltage (Vdc)	51.2
Nominal Capacity (Ah)	280
Standard Charging/Discharging current (A)	140
Dimension(W*D*H)	568*764*231mm
IP Grade	IP20
Operating Temperature	Charging 0°C~+60°C
	Discharging -20°C~+60°C
Operating Humidity	0%~95% RH (Non-condensing)
Storage Temperature	1 Month -20~45°C
	1 Year 0~35°C

! WARNING

- When battery leakage occurs, or there is abnormal smell from the battery, if it is difficult to determine whether the electrolyte leaks, please stop using it immediately and contact Dyness or professionals;
- Please do not touch the electrolyte directly, if skin contact accidentally, please flush with plenty of water;
- When handling leaking batteries, make sure that the power supply connected to the battery is off to prevent fire and sparks, and keep the environment well ventilated;
- Wear rubber gloves (insulation voltage>10kV) when handling leaking batteries;
- Please use gauze (ordinary medical gauze) or other liquid absorbent solids to clean the battery leakage;
- The treated battery should be placed in isolation and should not be used again;
- The above operations shall be completed by personnel designated by Dyness or qualified professionals.

3.7.2. BDU

The BDU module incorporating BMS and EMS.



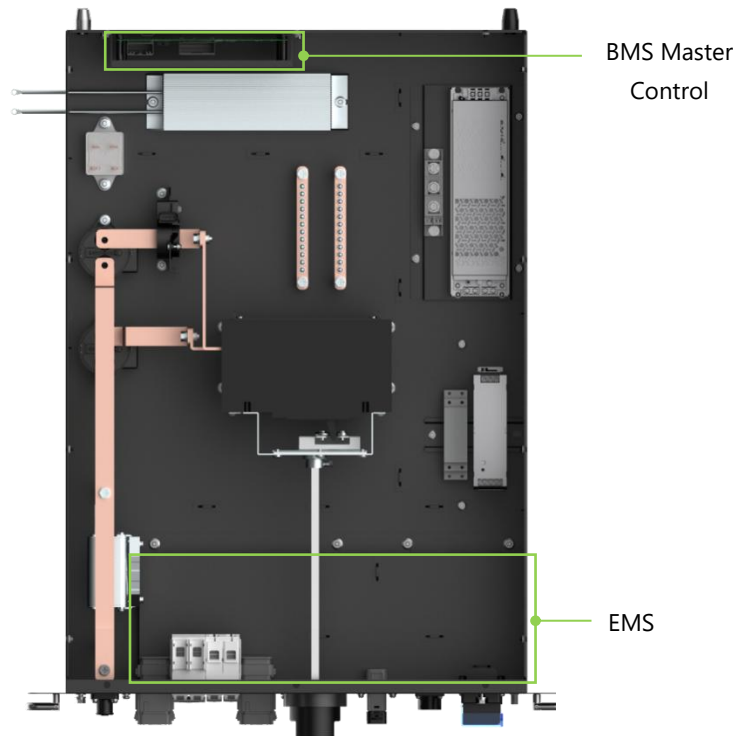

Figure 3-6 BDU Appearance & Top View

BMS Master Control

- Collect cell information from the PACK BMU, and transmitting it to the EMS.
- Calculate battery SOC and SOH based on the collected information, and execute overall control of the battery system.
- Ensure stable and safe battery functionality through real-time monitoring of battery status.
- Prolong battery lifespan by monitoring and regulating battery consistency.

EMS

- EMS is an important part of ESS, communicating with BMS, meters, fire systems, air conditioners and other equipment to control the whole ESS, which can realize the functions of energy arbitrage, peak shaving and off-peak filling, self-generation and self-consumption, and anti-backflow, etc. EMS collects data and signals from local equipment, and ensures the safe, reliable, efficient, and economic operation of the storage system through internal control strategies.

3.7.3. Security System

This system is equipped with an efficient and reliable firefighting system and access control system to effectively extinguish and alarm in the event of a fire or emergency.

Fire Protection System

- **Composite detector:** The product is equipped with a composite detector (smoke/temperature/ gas detector) and fire extinguishing agent on the top of the battery

compartment. When any of the three built-in detectors detects an anomaly, the system will stop operating and report the anomaly. If two detectors detect anomalies, the fire extinguishing agent will be released to suppress the fire, and a feedback signal will be sent to the EMS which can further relay the information to site monitoring or the user.

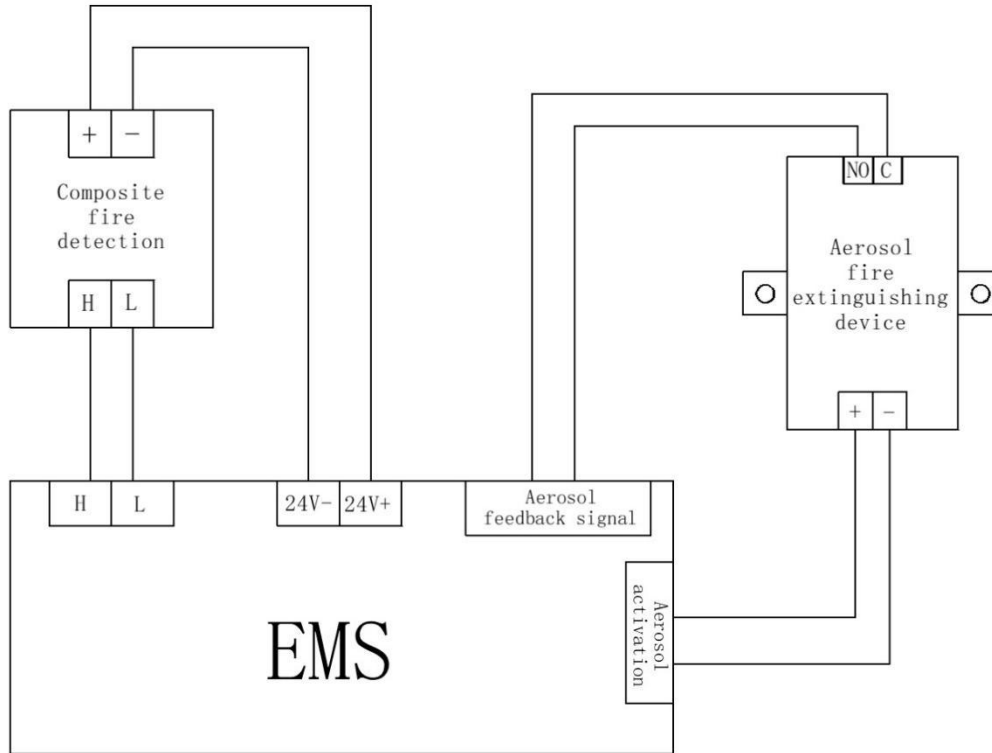

Figure 3-7 Fire Protection Principle

Access Control System

- **Water detector:** Installed at the bottom of the electricity compartment. In the event of an anomaly detected by the water detector, the system will report the anomaly and also stop operating.
- **Travel switch:** Installed at the top of the battery compartment to detect whether the door is tightly closed, preventing rainwater ingress.
- **GPS:** Locate where the system is installed to reduce the risk of theft.

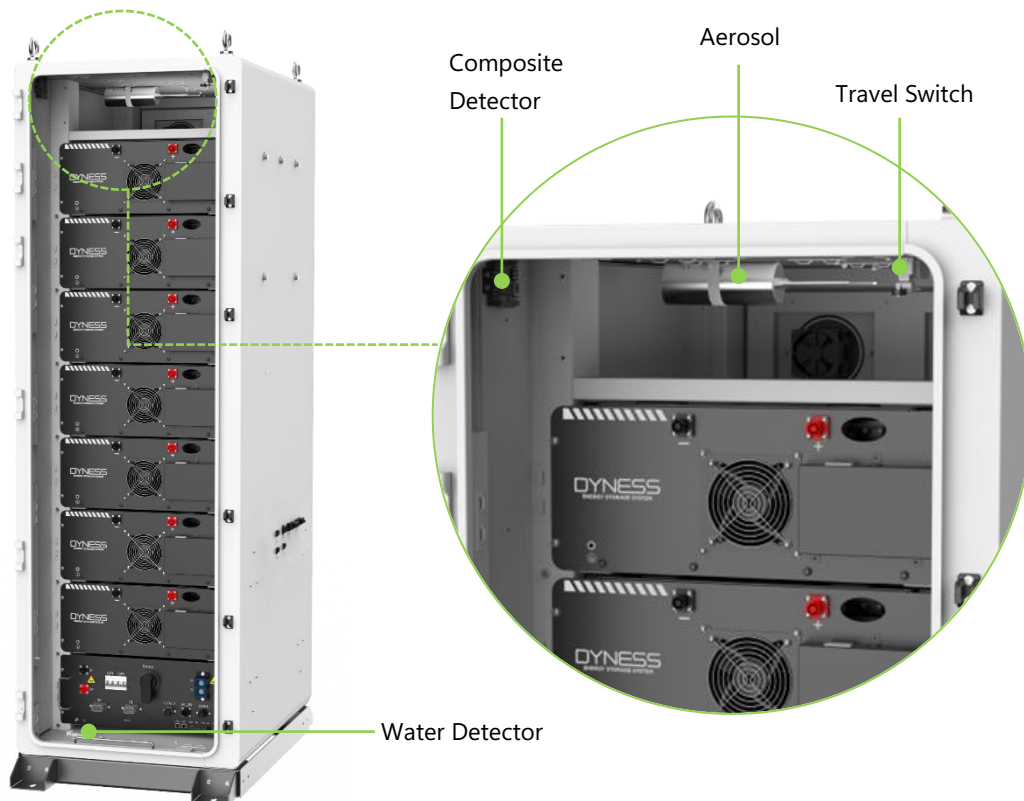

Figure 3-8 Security System

- The maintenance of the fire protection system should comply with the fire regulations of the country/region where the project is located.
- Fire protection equipment should be inspected and maintained regularly to ensure that all functional indicators are normal.

4. Transportation and Storage

Caution: Failure to transport and store in accordance with the requirements of this manual may void the warranty.

4.1. Unpacking and Checking

- After receiving the product, please check whether all the delivered components are complete against the "supply list";
- Please check whether the actual received cabinet and the received product mode is the same as the ordered model;
- Carefully check whether the product is in good condition, the transportation process may lead to damage due to transportation collision, if any problem is found, please contact Dyness or the transportation company in time.

Shipping Requirement

- All necessary equipment in the product have been installed and fixed in the cabinet before leaving the factory, and the product can be transported as a whole during transportation;
- Please confirm that the cabinet doors of the equipment are tightly locked before transportation;
- The transportation of a single ESS cabinet requires wooden box packaging, reserve buffer between the wooden box and ESS cabinet;
- Be sure to set up warning signs or caution tape to prevent unauthorized personnel from entering the lifting and transportation area to avoid accidents;
- Remove any existing or potential obstacles during the moving process, such as trees, cables, etc;
- Whenever possible, choose favorable weather conditions for transporting the equipment.

Requirements For Equipment Transportation Mobility

- Select a suitable crane or lifting tool according to the site conditions. The selected tool must have sufficient load-bearing capacity, arm length, and rotation radius;
- If movement on slopes or similar conditions is required, additional traction devices may be necessary;
- When carrying out ground transportation, be sure to use ropes to secure the top lifting ring of the equipment to the transport vehicle to prevent excessive tilting during transportation.

4.2. Lifting Transportation

This product is equipped with a lifting ring at the top for lifting, and can be transported by lifting. The following requirements must be met when lifting the products:

- Ensure site safety when lifting;
- When lifting and installing, professional personnel should be in charge of the whole process;
- The strength of the slings should be able to withstand the weight of the equipment;

- Ensure that all sling connections are safe and reliable, and ensure that each section of the sling connected to the corner piece is of equal length;
- The length of the slings can be adjusted appropriately according to the actual requirements of the site;
- Make sure that the equipment remains stable and does not tilt during lifting process;
- The equipment shall be suspended after being lifted from the ground by 300mm, and check that the lifting device is firmly connected before lifting;
- Take all necessary auxiliary measures to ensure safety.

Caution: The hanging rings need to be installed on site, please ensure that the hanging ring bolts are tightened before lifting.



Figure 4-1 Lifting Transportation

4.3. Forklift Transportation

The bottom of this product is equipped with fork holes specially designed for forklift transportation. The product can be moved through the bottom fork holes on the left and right. If the installation site is flat, the product can be moved using a forklift. Forklift transportation methods should meet the following requirements:

- The forklift should be equipped with sufficient load capacity;
- The length of the pins should meet the requirements of the equipment;
- The pins should be inserted into the fork holes at the bottom of the workstation;
- Moving and lowering should be slow and steady during forklift transportation;
- Products should only be placed on stable surfaces. The area should be well-drained, free of any obstacles or protrusions;
- Under no circumstances should the unit be moved by inserting the pins into a position other than the fork holes.

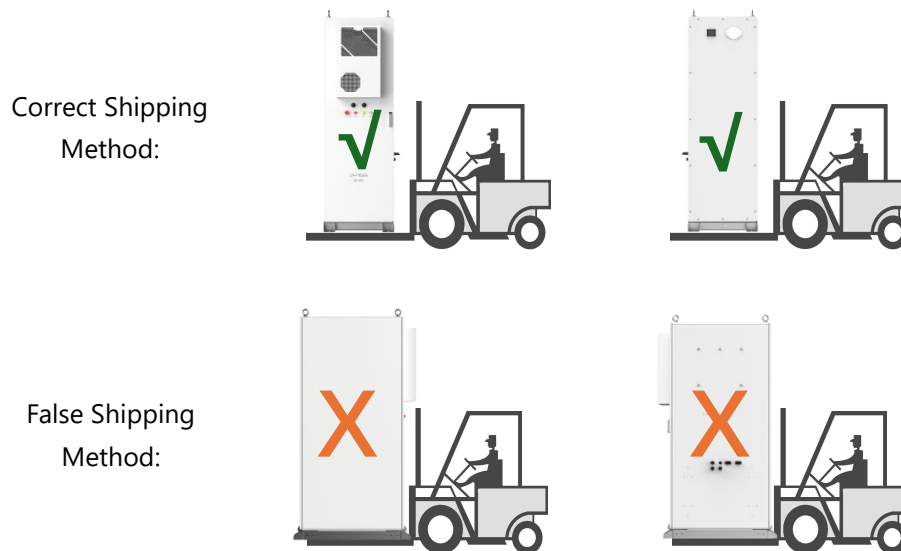

Figure 4-2 Forklift Transportation

4.4. Storage Requirement

Storage Environment Requirements

- The product should be stored on dry, flat (flatness should be no more than 5mm), solid ground with sufficient load-bearing capacity and without any vegetation cover;
- To prevent condensation inside the product or soaking of the bottom of the product during the rainy season, the product should be stored on higher ground;
- The basement must be raised, and the specific elevation height should be determined according to the site geology, meteorological conditions and other conditions;
- Storage environment temperature: 0~+35℃, Humidity: 0~95%(Non-condensation);
- Pay attention to cope with the harsh environment around, such as sudden cold, sudden heat, collision, etc., so as not to cause damage to the PACK.

Storage Operating Requirements

- Packing boxes should not be tilted or inverted;
- Make sure that the cabinet doors are securely locked before storage;
- Effectively protect the product's air inlet/outlet to prevent rainwater, sand, and dust from entering the interior of the cabinet;
- Due to the capacity decay that occurs during long-term storage, it is not recommended to store batteries exceeding six months;

- For products stored for a long period (more than six months), inspecting visually before installation to ensure there is no condensation and verify if the equipment is intact. Additionally, checking after powering on;
- Perform regular inspections, more inspection programs please refer to chapter 9.

**NOTE**

Starting from the date of delivery, perform one charge and discharge cycle for the PACK every 6 months, to maintain the system SOC of 25~40%.

5. Installation

Only a qualified electrical engineer can operate related electrical connection. Please comply with the requirements given in "Safety Instructions" in this manual and we shall not be liable for casualties or property loss caused by neglect of safety instructions.



DANGER

- Do not touch the live parts!
- Ensure both AC and DC sides are not energized before installation. All electrical connections must be operated under de-energized condition;
- Check the polarity of all input cables to ensure that each input polarity is correct before wiring;
- Do not place the equipment on surfaces that are flammable.



WARNING

- The ingress of sand and moisture may damage the electrical equipment inside the ESS cabinet or affect the performance of the equipment!
- During sandstorm seasons or when the relative environmental humidity exceeds 95%, electrical connection work should be avoided;
- Wait until there are no sandstorms and the weather is clear and dry before starting any connection work;
- Avoid pulling or tugging on cables or wires forcefully to prevent damage to their insulation performance during electrical installation.



CAUTION

- All cables and wires should be ensured to have a certain amount of bending space;
- Necessary auxiliary measures should be taken to reduce the stress on cables or wires;
- After completing each step of the wiring operation, careful inspection is required to ensure correct and secure connections;
- All electrical connections must be strictly in accordance with the wiring diagram.

5.1. Installation Environmental Requirements

Site Requirements

- When selecting the installation site, full consideration should be given to the surrounding environment (climate and geological conditions, such as stress wave emission, underground water level, no high cables in the vertical upper part of the installation site, no pipelines or other underground facilities in the lower part of the installation site, and a certain safety distance should be maintained between the equipment and buildings and people, the length of the distance should be subject to the fire safety regulations of the project);
- The surrounding environment should be dry and well ventilated;
- Please ensure that there are no trees around the installation location to prevent branches or leaves from blocking the doors or air inlets of the energy storage integrated system during strong winds;
- The installation location should be away from toxic and harmful gas and flammable, explosive, corrosive, and dust-intensive materials;
- The installation location should be away from residential areas to avoid noise.

Foundation Requirements

- The foundation should provide sufficient load-bearing support for the equipment;
- The height of the foundation should be higher than the historical highest flood level;
- The basic bearing capacity $> 3\text{t}/\text{m}^2$, the basic service life > 50 years, and the basic level $< 3\text{mm}/\text{m}^2$;
- The ESS cabinet should be raised to against the rain. The recommended mounting height of the base is about 300mm-500mm higher than the ground;
- Drainage measures should be constructed according to local geological conditions.

Wiring Requirements

- According to the positions and dimensions of the cable inlets/outlets, sufficient space should be reserved for the AC side cable trough and the cable guide should be inserted in advance during foundation construction;
- The specifications and quantity of perforated pipes are based on the cable model and quantity of the cable;
- Both ends of all embedded pipes are temporarily sealed to avoid impurities from entering. Otherwise, later wiring is inconvenient;
- After connecting all the cables, inlets, outlets and connectors of the cable should be sealed with refractory clay or other suitable material to avoid entry of rodents.

5.2. Installation Spatial Requirements

The product adopts front-rear ventilation. Make sure that the equipment has enough space for better cooling and maintenance, it is advised to reserve enough space around the cabinet installation position:

- The space reservation distance at the front of the product is not less than 800mm;
- The space reservation distance at the rear of the product is not less than 600mm;
- The space reservation distance of the left of the product is not less than 500mm;
- The space reservation distance of the right of the product is not less than 1000mm.



Figure 5-1 Single Product Dimension

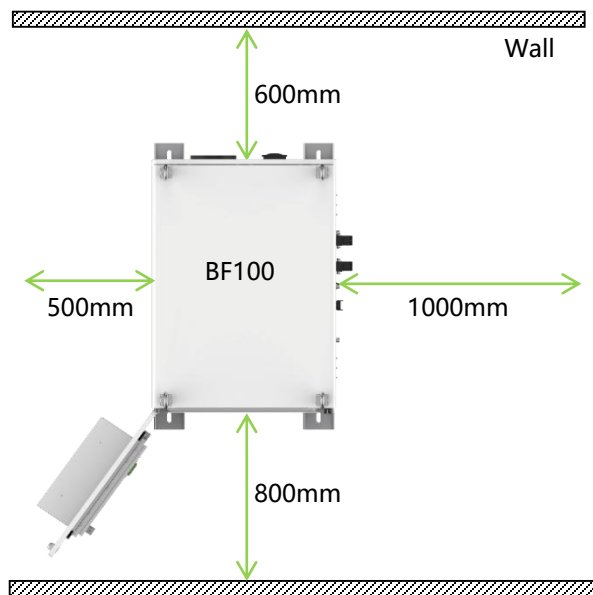
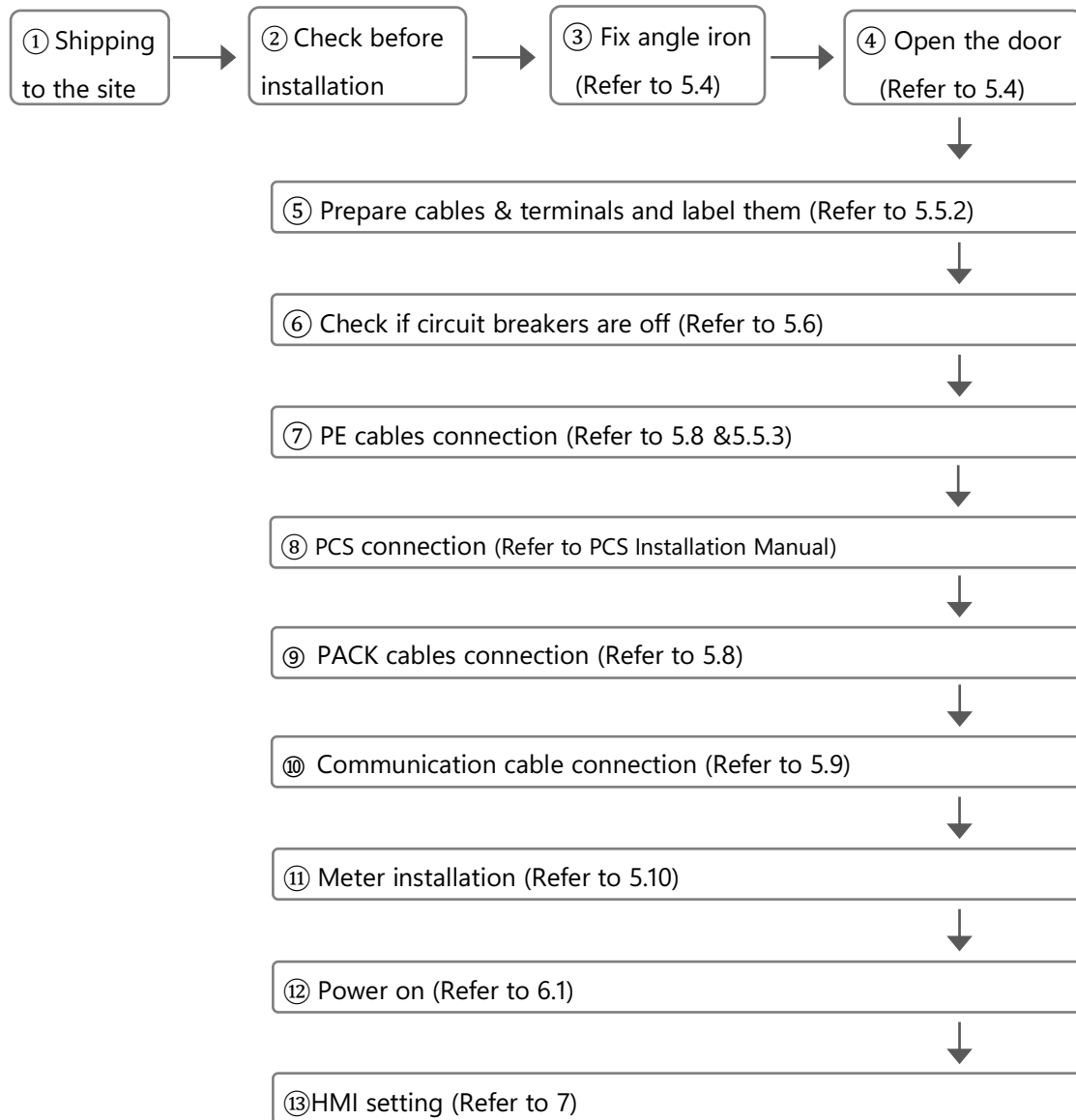

Figure 5-2 Space for Single Product Installation

5.3. Installation Procedure

Product installation please follow the below steps, The specific operation process is detailed in this chapter:



5.4. Fixed Installation

Check Before Installation



WARNING

Please comply with local safety regulations and operational rules during installation. Only complete and undamaged equipment can be installed! Please ensure that before installation:

- The product cabinet itself should be complete and intact;
- All equipment in the cabinet should be complete and intact.

Install Angle Iron Brackets & Expansion Bolts

The product adopts right side cable outlet, concrete column is not necessary.

After shipping the product to the installation site, it shall be fixed. Four L-shaped angle iron brackets are pre-reserved at the front/back of the product base, as shown in the below diagram.

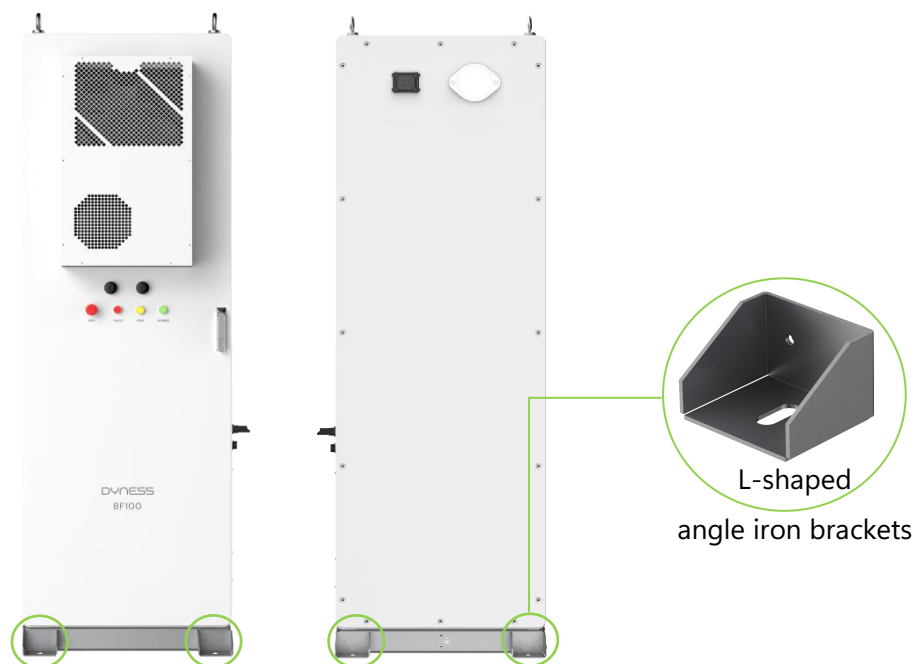

Figure 5-3 Angle Iron Brackets

Notice: The L-shaped angle iron brackets can be rotated, so the angle iron brackets could be installed at the side of the product too.

The following tools may be needed for installing the brackets: marker pen, electric drill, angle iron, M12 expansion bolts. These tools are not included in the supply list and need to be provided by the customer.

L-shaped Angle Iron Brackets Installation Steps

- ① Use a marker pen to mark the drilling positions;
- ② Choose an electric drill with a diameter matching the bolt's outer diameter, drill holes according to the bolt's length (hole depth slightly greater than the bolt length) until reaching the desired depth for installation;
- ③ Insert the bolt and expansion sleeve into the hole, tighten the nut to the end of the bolt, and use a wrench to tighten it.

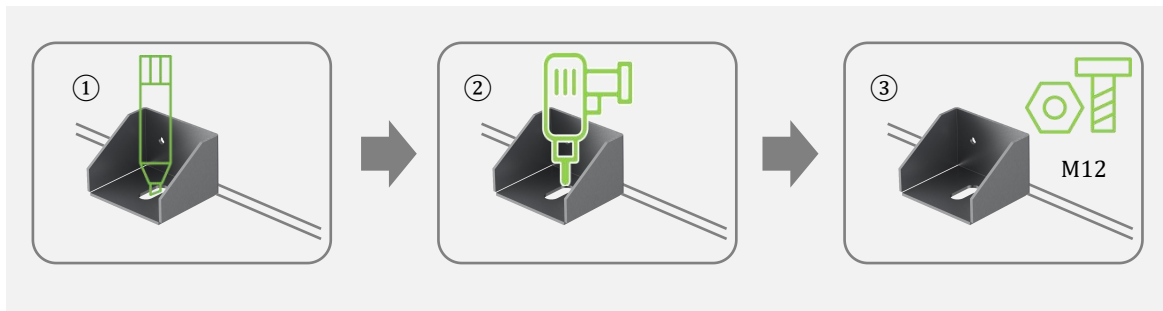

Figure 5-4 Angle Iron Brackets Installation Steps

Door Open Steps

- ① Make sure that the equipment is under lock state;
- ② Moving the lid up above the locking hole;
- ③ Plug in the key in the door and revolve it clockwise;
- ④ Rotating the handle clockwise to the position shown in the figure to open the door.

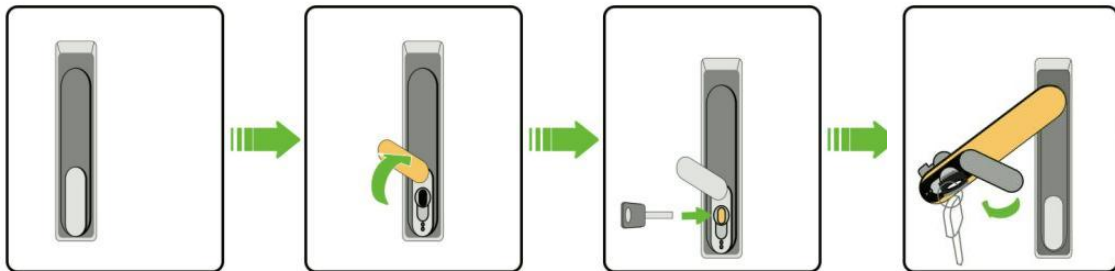

Figure 5-5 Door Open Steps

5.5. Preparation Before Installation

5.5.1. Wiring Tools

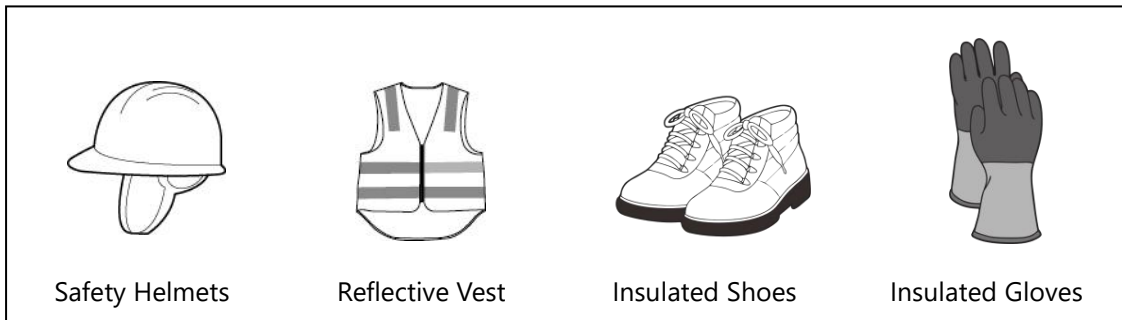

Figure 5-6 Safety Gear

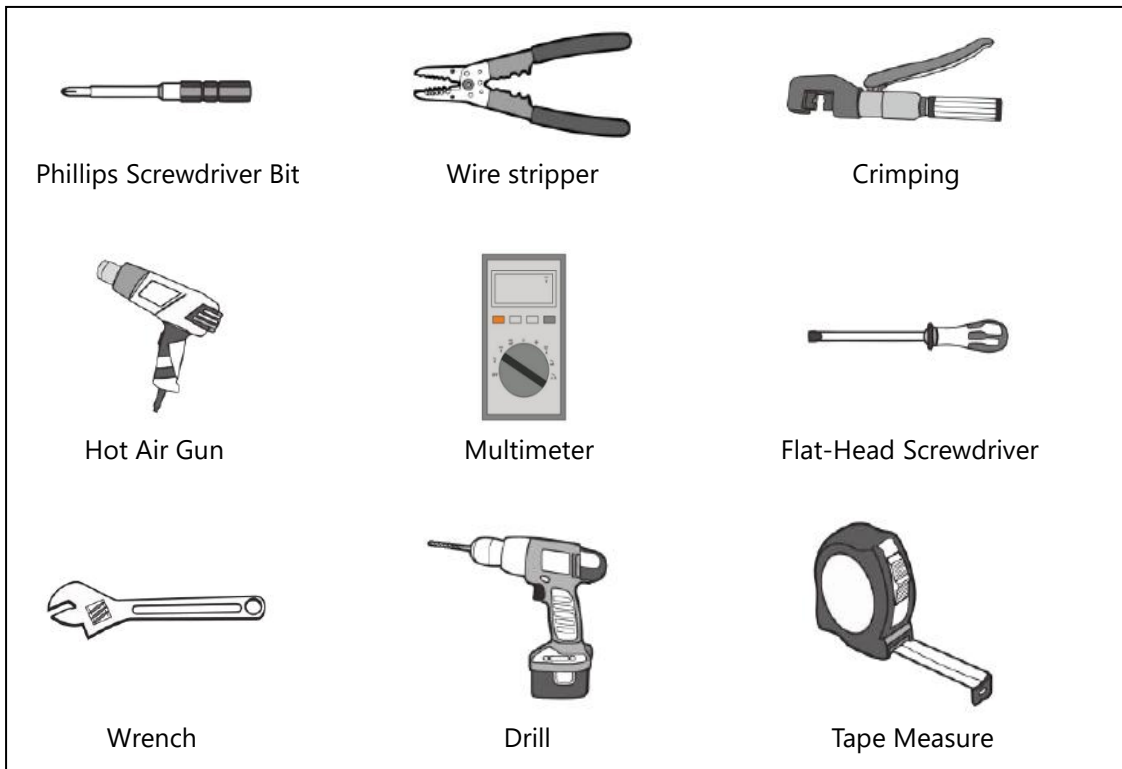

Figure 5-7 Tools





5.5.2. Wiring Accessories Requirements

Cable Requirements:

- Having sufficient current-carrying capacity. The cable diameter must satisfy the maximum current-carrying capacity, and the length must allow for a margin;
- Be sure to choose flame-retardant cables;
- The cables used shall comply with the requirements of the local laws and regulations.

Notice: The following accessories need to be prepared by the customer.

Table 5-1 Wiring Accessories

NO.	Type	Function	Specifications	Qty	Note
1	PE cable	Grounding cable	6AWG	As demand	
2	Cable terminal	Copper terminal	DT/SC 16-6	As demand	
3	Control cable	For connecting to other external devices	16AWG	As demand	
4	Sample cable	Meter Voltage and Current collection cables	Voltage: 16AWG Current: 14AWG	As demand	
5	Grounding bar	For grounding	40*4mm	As demand	

5.5.3. Terminal Wiring Method

OT/DT terminals connection step:

- (1) Peel off the insulation skin from the cable terminal, and the length of which should be the depth of the wire hole on the copper terminal, plus an additional 2-3mm;
- (2) Install the heat-shrink sleeve at the cable terminal and insert the exposed copper core part of the stripped wire into the wire hole of the copper terminal (OT/DT terminal);
- (3) Use hydraulic pliers to firmly crimp the copper terminal;
- (4) Slide the heat-shrink tube onto the copper terminal (OT/DT terminal) to fully cover the wire hole. Use a heat gun to tighten the heat-shrink tube.

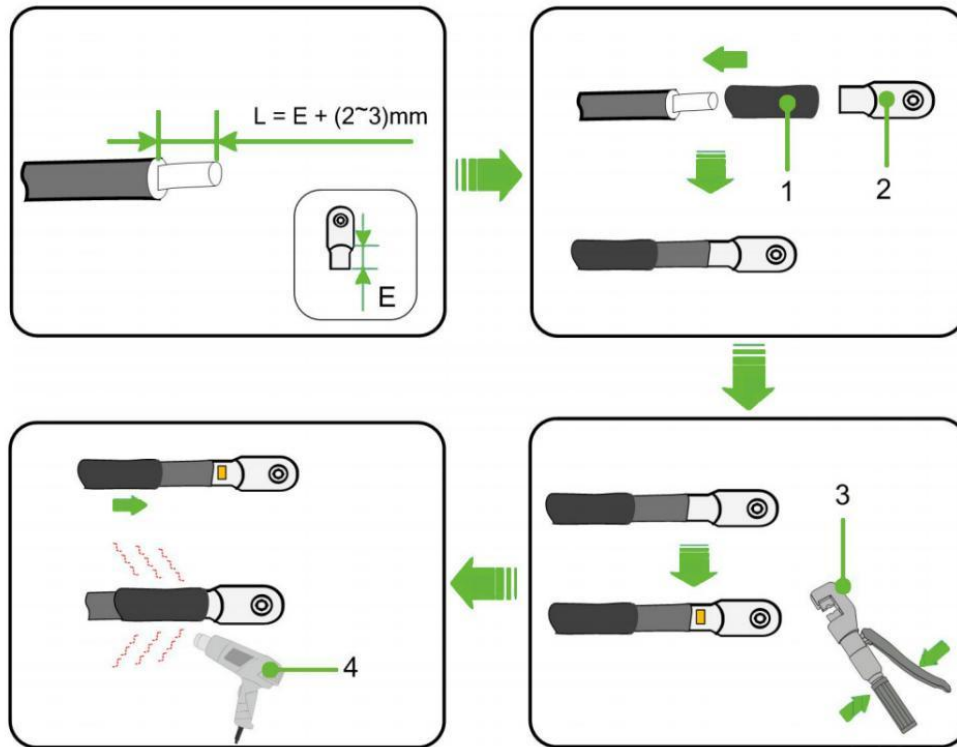

Figure 5-8 The Connection Sequence of Wiring Components

- 1: Heat-shrink tube
- 2: OT/DT terminal
- 3: Crimping Pliers
- 4: Hot air gun

5.6. Checking Before Wiring

1) Checking Breakers

Check whether the next following circuit breakers is in the disconnected position:

- Air switch "QF1""QF2" on the front panel (As shown in position 1);
- Battery breaker ("Battery") on the front panel (As shown in position 2).

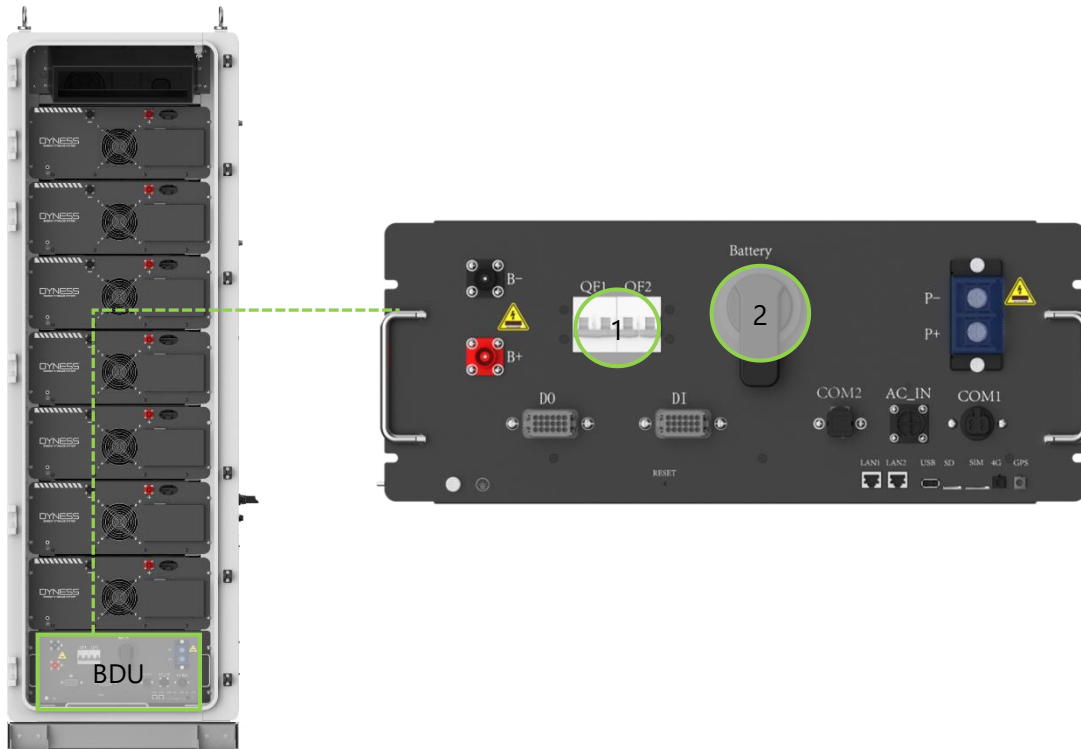

Figure 5-9 Breakers Location

2) Checking Before Wiring

Table 5-2 Checking List Before Wiring

No.	Checklist	Confirm
1	The cables and terminals used should meet the requirements of wire diameter and shielding;	<input type="checkbox"/>
2	The cable are labeled correctly;	<input type="checkbox"/>
3	The related wiring accessories are ready;	<input type="checkbox"/>
4	The wiring operator have worn protective devices;	<input type="checkbox"/>
5	Checking if all the breakers are in disconnected position.	<input type="checkbox"/>

5.7. PE Wiring

The grounding connection must comply with local laws and regulation. Please consider the actual situation at project site and follow the instructions of the power station staff during the process of ground connection, the grounding connection is shown as follows:

- (1) Reserve grounding point, which can be grounded by cable/flat steel;
- (2) Use 6AWG grounding cable, grounding cables and terminal requirements should refer to 5.5.2.

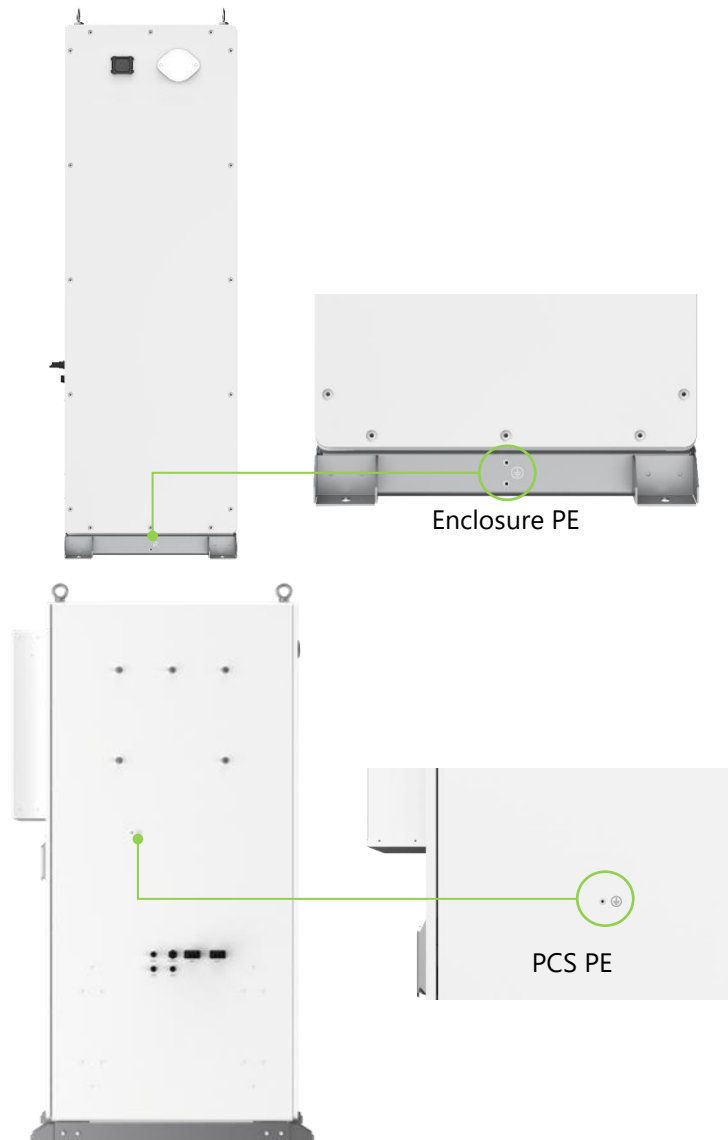

Figure 5-10 Battery Cabinet Grounding

After the grounding connection, the grounding resistance must be measured, and the specific grounding resistance value must comply with relevant region/local standards and regulations.

5.8. Electrical Wiring

Step 1 Internal Wiring

To ensure the safety of the product, the PACK power cables for the batteries are shipped with the product and need to be installed on-site as follows:

- (1) Please reconfirm the battery switch is off (As shown in position 1);
- (2) PACK cables connections: connect the PACK in series with cables, where the negative terminal of the upper PACK is connected to the positive terminal of the

- lower PACK, please ensure the connection sequence is correct;
- (3) PACK and BDU connection: the positive terminal of PACK is connected to the positive terminal of BDU, the negative terminal of PACK is connected to the negative terminal of BDU.

Notice : The color of PACK and BDU terminals: red represents positive, black represent negative.

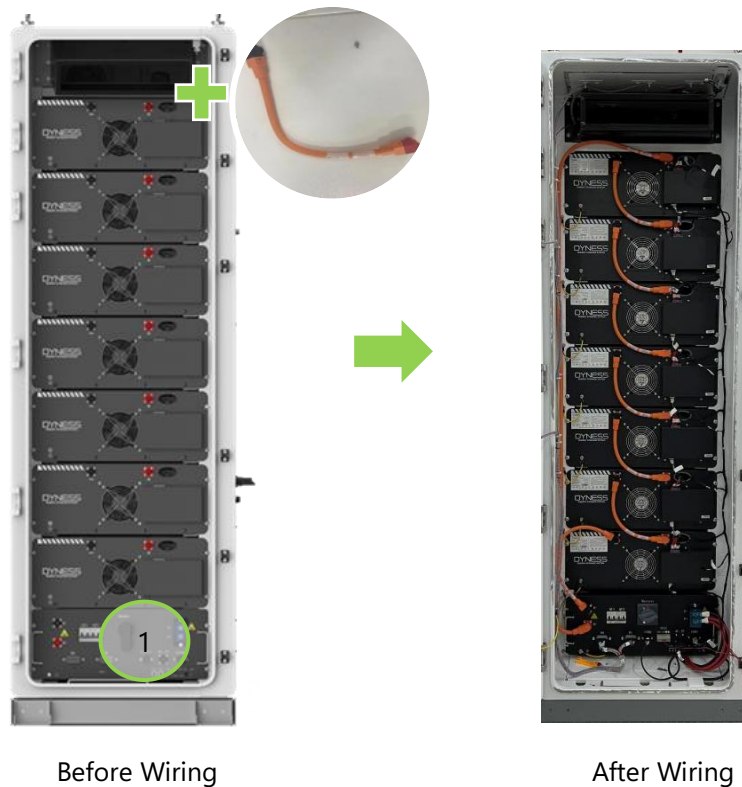

Figure 5-11 PACK Cables Connections

Step 2 External Wiring

The product supports external connection to PCS, and the following external interfaces are defined:

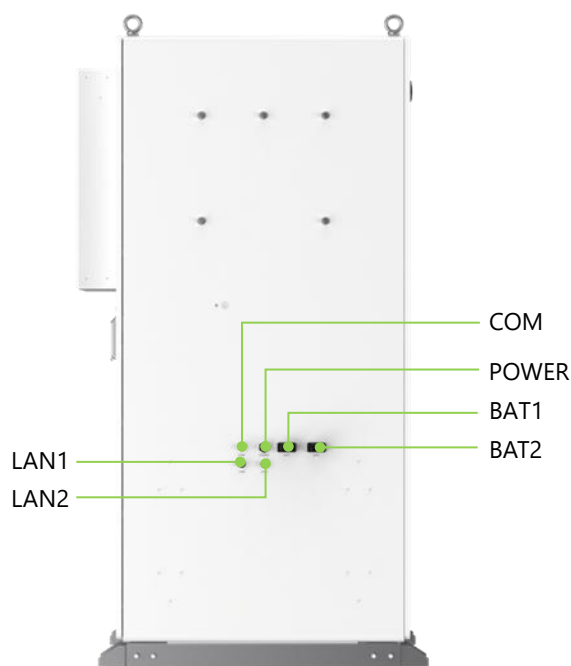

Figure 5-12 External Interface

Table 5-3 External Interface Definition

No.	Label	Definition
1	COM	External communication port
2	POWER	AC230V External power input
3	BAT1	Battery interface 1
4	BAT2	Battery interface 2
5	LAN1	External communication Ethernet port 1
6	LAN2	External communication Ethernet port 2

5.9. Communication Wiring

The EMS of this product is integrated in the BDU, and the external communication interface as shown in the below diagram;

The product is adjustable to multiple protocol, it has multiple external ports: LAN, USB, CAN, 4G, GPS, SD, SIM card;

Be sure to use correct communication cables (18AWG recommended).



Figure 5-13 Communication Port

Table 5-4 Communication Port Definition

No.	Label	Definition
1	LAN1	LAN port 1 for connecting Ethernet and local host computer(In reserve)
2	LAN2	LAN port 2 for connecting Ethernet and local host computer
3	USB	USB port, for EMS local program upgrade
4	SD	SD card port, for local data storage
5	SIM	SIM card port
6	4G	4G antenna port
7	GPS	GPS antenna port

5.10. Checking After Wiring

Please check the following checklist after wiring to avoid equipment damage.

Table 5-5 Checklist Before Wiring

NO.	Checklist	Confirm
1	Please disconnect the user's grid-side switch and the DC-side switch of the battery cabinet, please ensure the AC side and DC side of PCS not energized;	<input type="checkbox"/>
2	Please check if the negative and positive connection of battery, the AC phase of PCS are connected correct. Measure the resistance between the three phase, which should be in the MΩ level, if it is in kΩ level or smaller, please check the circuit;	<input type="checkbox"/>
3	Check if External cables, PE cables and communication cables are well	<input type="checkbox"/>

	connected.	
4	The PE cable resistance should be less than 0.1Ω , the cable is intact and has no damage or cracks;	<input type="checkbox"/>
5	Clean the installation area and ensure that there are no tools or other irrelevant objects left inside the ESS cabinet;	<input type="checkbox"/>
6	Use fireproof and waterproof materials to tightly seal the openings and gaps around the ESS cabinet's entry and exit holes.	<input type="checkbox"/>

6. Power On and Power Off

6.1. Power On Process

Precautions

- The product can only be put into operation after being confirmed by professionals and approved by the local power department.
- For products with a long shutdown time, before powering on, a comprehensive and detailed inspection must be carried out on the equipment to ensure that all indicators meet the requirements before powering on.

Check before power on

Table 6-1 Checklist Before Power On

NO.	Checklist	Confirm
1	Check if the wiring is correct;	<input type="checkbox"/>
2	Check if the emergency stop button is released;	<input type="checkbox"/>
3	Check PE cable connection to make sure there are no ground faults;	<input type="checkbox"/>
4	Check if the AC and DC voltages meet the start-up conditions and there is no risk of over-voltage with multimeter;	<input type="checkbox"/>
5	Check to make sure no tools or parts are left inside the device;	<input type="checkbox"/>
6	Check if there is condensation, if so, must open the ESS cabinet for ventilation until condensation disappears;	<input type="checkbox"/>
7	Check if there are no wire ends, metal shavings and other objects that may cause short circuits in signal or power cables.	<input type="checkbox"/>

Power on step

- Step 1: Close "Battery" breaker on the BDU;
- Step 2: Close "QF1", "QF2" breakers on the BDU in sequence.

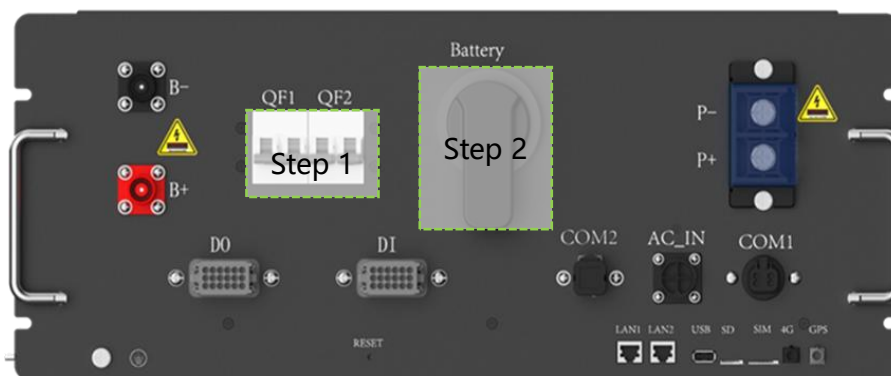

Figure 6-1 BDU Operation

After operating the steps one by one, check whether the indicator light of the product is on and whether the screen is displayed. If the product status is normal, the "POWER" and "RUN" indicator light are on, and "FAULT" indicator is off. The screen starts to display the system running status and parameters.

6.2. Power Off Process

Operation process could refer to the above image

- Step 1: Disconnect "QF1", "QF2" breakers on the BDU in sequence;
- Step 2: Disconnect "Battery" breaker on the BDU.



WARNING

After operating step by step, the system will stop running, and the product indicators and screen will go out. After the inspection is completed, wait for five minutes to perform maintenance and inspection operations.

6.3. Emergency Stop

Press the "EPO" red button on the front door when there is an emergency.



Figure 6-2 EPO Location

**WARNING**

Under normal circumstances, please use the normal shutdown procedure to power off the product! In emergency situations, it is necessary to use EPO to ensure quick response and protect personal and equipment safety!

7. HMI Operation

7.1. Operation System Overview

The product is equipped with 7-inch screen, on where the users could check the system information and set system parameters.

Table 7-1 HMI Interface Overview

Main Window	Main Menu	Level 1	Main Window	Main Menu	
Main interface	Dashboard	Grid			
		PCS			
		Battery			
		Load			
		PV-DC			
		Gen			
	Data	EMS		Status	
				Parallel	
				INV/CHG data	
				S-P-F-V data	
		BMS data		Basic	
				Volt	
				Temp	
				Alarm	
		PCS data		Basic	
				Alarm	
		Sys Data		Meter	
				Air-Cond	
				L-cooling	
		Alarm Info		Alarm	
				History	
		Version Info			
	Setting	EMS		RunSet	Auto
				DataSet	Remote
				SysSet	SysParam
	Login		Permission		
			Modify		
				Basic Set	

Please notice: the HMI interface may vary with version update, the images in this chapter is only for reference.

HMI Main Interface

- **Dashboard:** Display the details of system access device;
- **Data:** Query the detailed data, alarm information, version information of each sub-module of the system;
- **Setting:** Setting the related system parameters (please notice the user could only change the EMS parameters);
- **Login:** The permission for login the system.

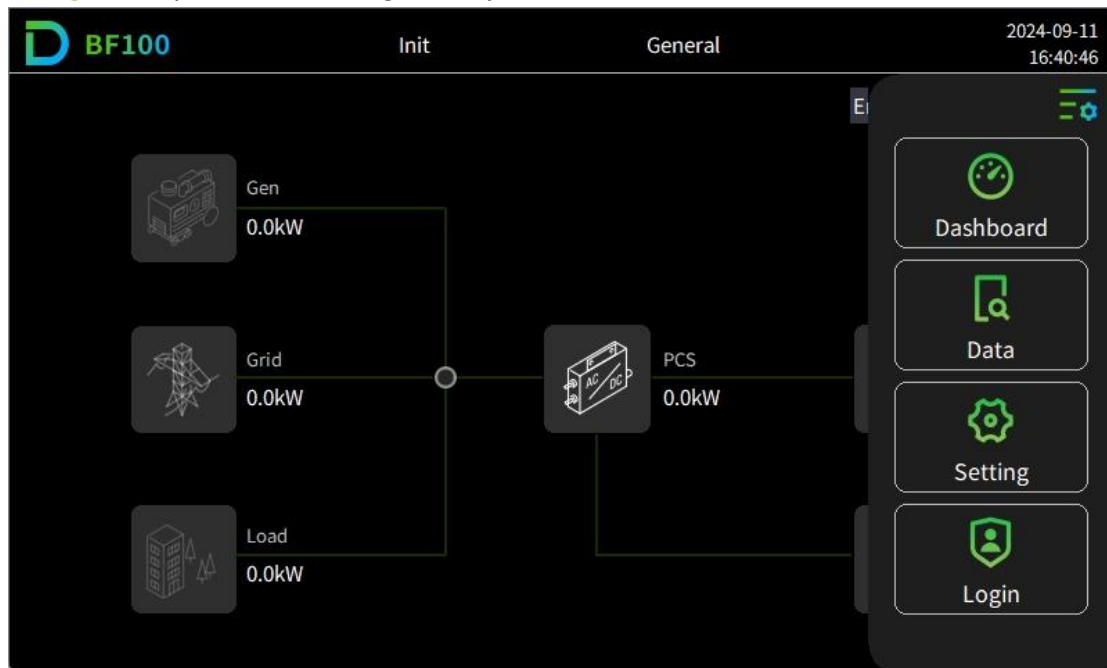



Figure 7-1 HMI Main Interface

7.2. User Login

Table 7-2 Login Permission Description

Permission	Description
Not login	When not log in, the user could only read the system running data, cannot set the device.
General user	The user could check the system running data and set related system parameters. This permission is only open to on-site installation personnel, the original password is 1111.
Advanced user	Only open to the manufacturer staff.

Login step

- Step 1: Click main menu icon  on the upper right corner of the main interface;
- Step 2: Click "Login" to enter the user interface under the main menu bar;
- Step 3: Select "General", input password(1111), click "Login";
- Step 4: Click "Confirm" in the prompt popup.

—END



Figure 7-2 General User Login Step

Change password

- Step 1: Click "Modify" at the upper left of navigation bar;
- Step 2: Input old password and new password, complete the setting, then click "Confirm modification".

—END

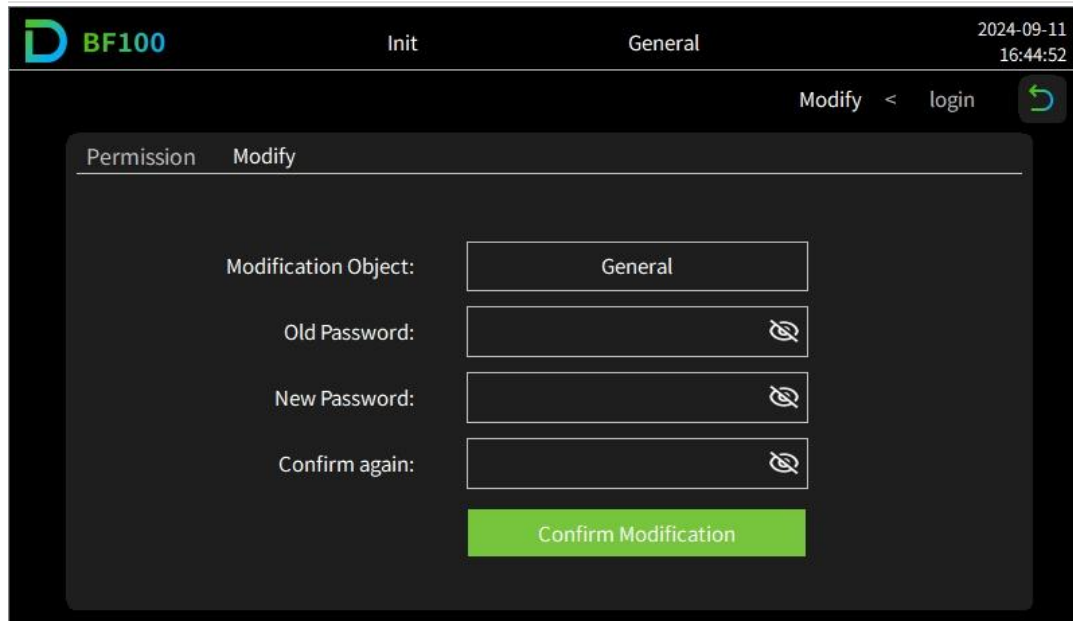







Figure 7-3 Change Password Diagram

7.3. Running Information

Method 1

Click corresponding icons on the main interface and directly enter corresponding module data interface.

- Click Gen icon , enter Gen interface;
- Click Grid icon , enter Grid interface;
- Click load icon , enter Load interface;
- Click PCS icon , enter PCS interface;
- Click battery icon , enter Battery interface;
- Click PV-DC icon , enter PV-DC interface.

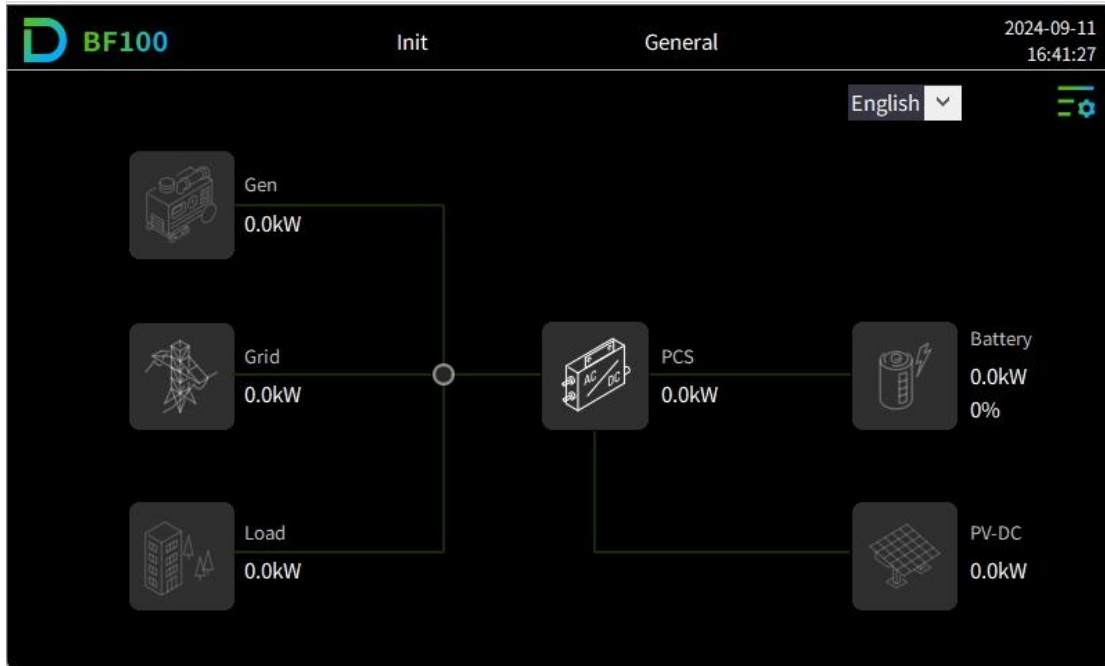



Figure 7-4 Main Interface Module Diagram

Method 2

- Step 1: Click main menu icon  on the upper right corner of the main interface;
- Step 2: Click “Dashboard” under main menu bar;
- Step 3: Select corresponding sub-menu (Grid/ PCS / Battery / Load/ PV-DC/ Gen) as needed.

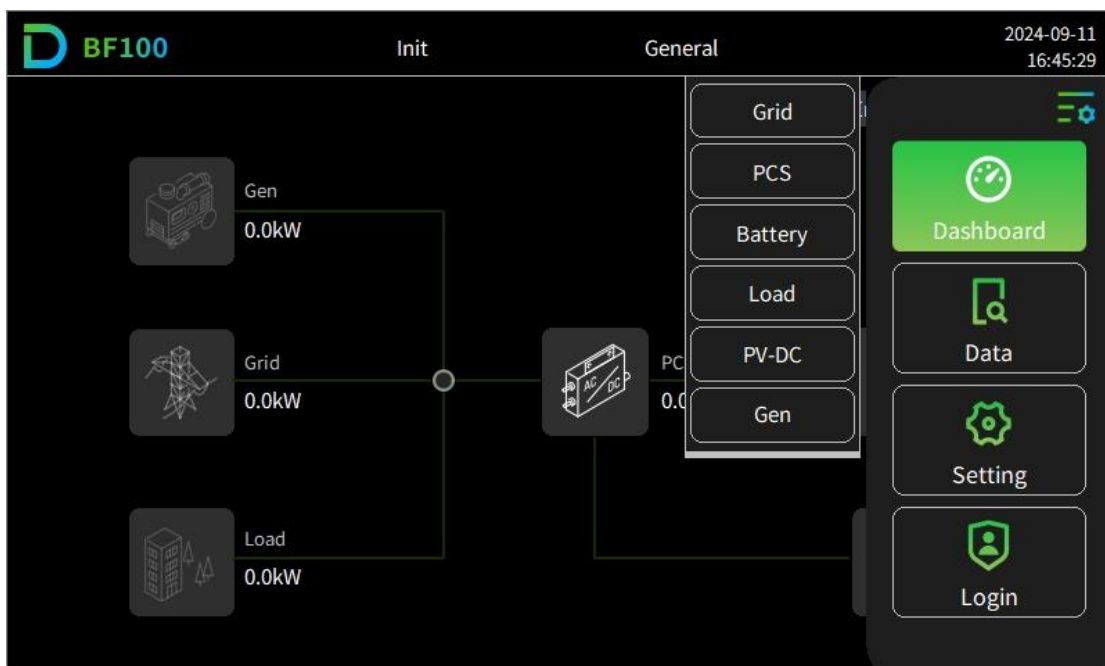



Figure 7-5 System Running Information Overview

7.4. Query Data

- Step 1: Click main menu icon  on the upper right corner of the main interface;
- Step 2: Click "Data" under main menu bar;
- Step 3: Select corresponding sub-menu (EMS/ BMS data/ PCS data/ Sys data/ Alarm Info / Version Info) as needed.

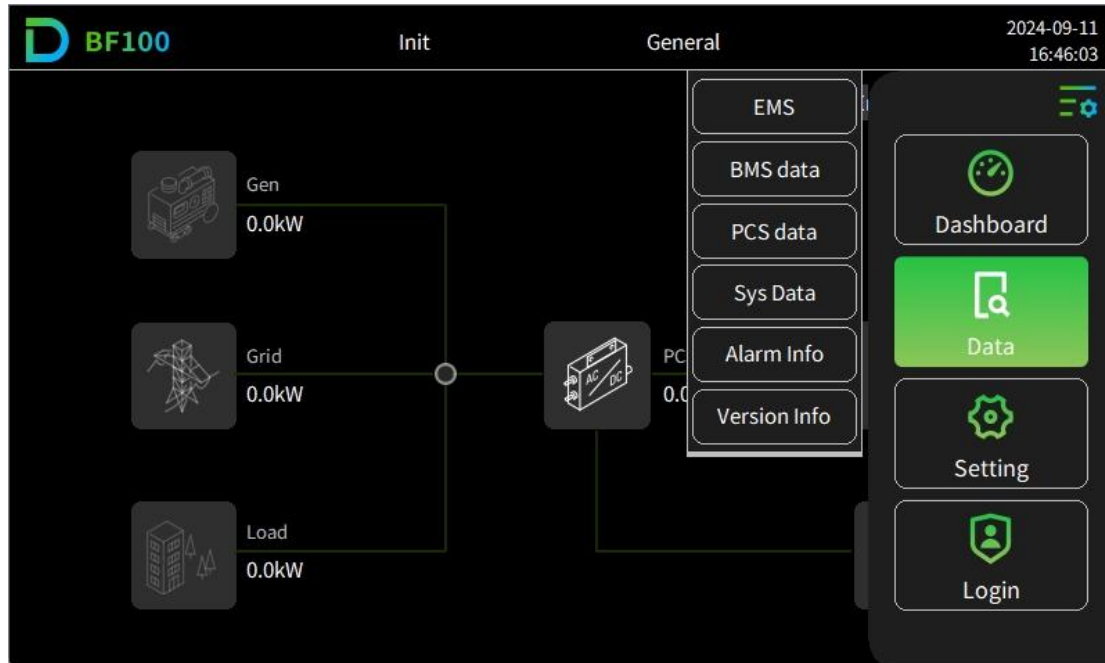



Figure 7-6 Query Data Diagram

7.5. EMS Setting

7.5.1. Run Setting

The operation setting interface is for setting "Auto power on" "Set Mode" "Manual Switch".

- Step 1: Click main menu icon  on the upper right corner of the main interface;
- Step 2: Click "Setting" under main menu bar;
- Step 3: Click "EMS" under sub-menu bar;
- Step 4: Click "RunSet" at the upper left of navigation bar.

——END

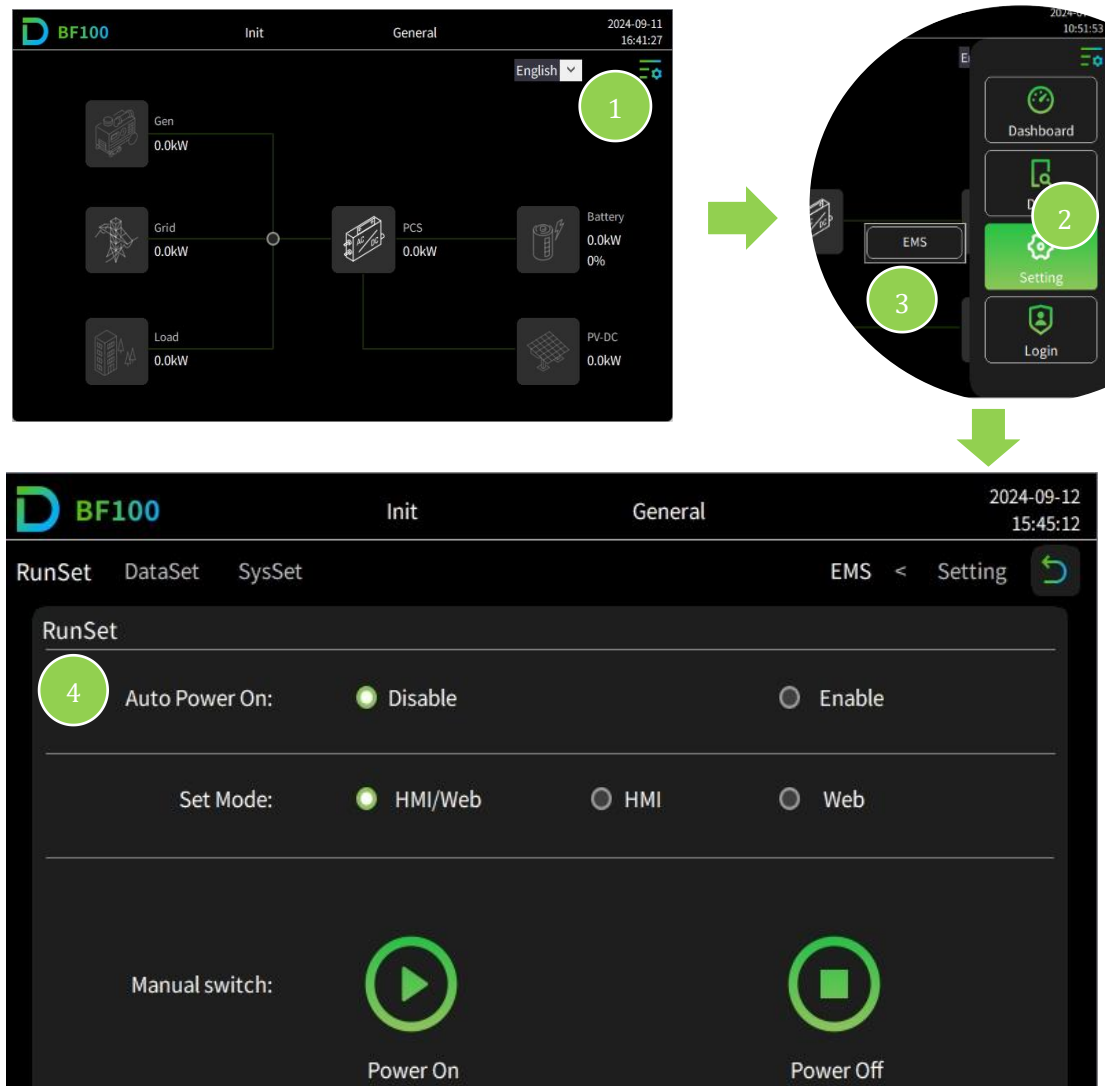



Figure 7-7 Running Setting Step

7.5.2. Parameter Setting

Parameter setting interface for "Fault Reset", "System Restart", "Restore Factory Set".

- Step 1: Click main menu icon  on the upper right corner of the main interface;
- Step 2: Click "Setting" under main menu bar;
- Step 3: Click "EMS" under sub-menu bar;
- Step 4: Click "DataSet" at the upper left of navigation bar.

——END

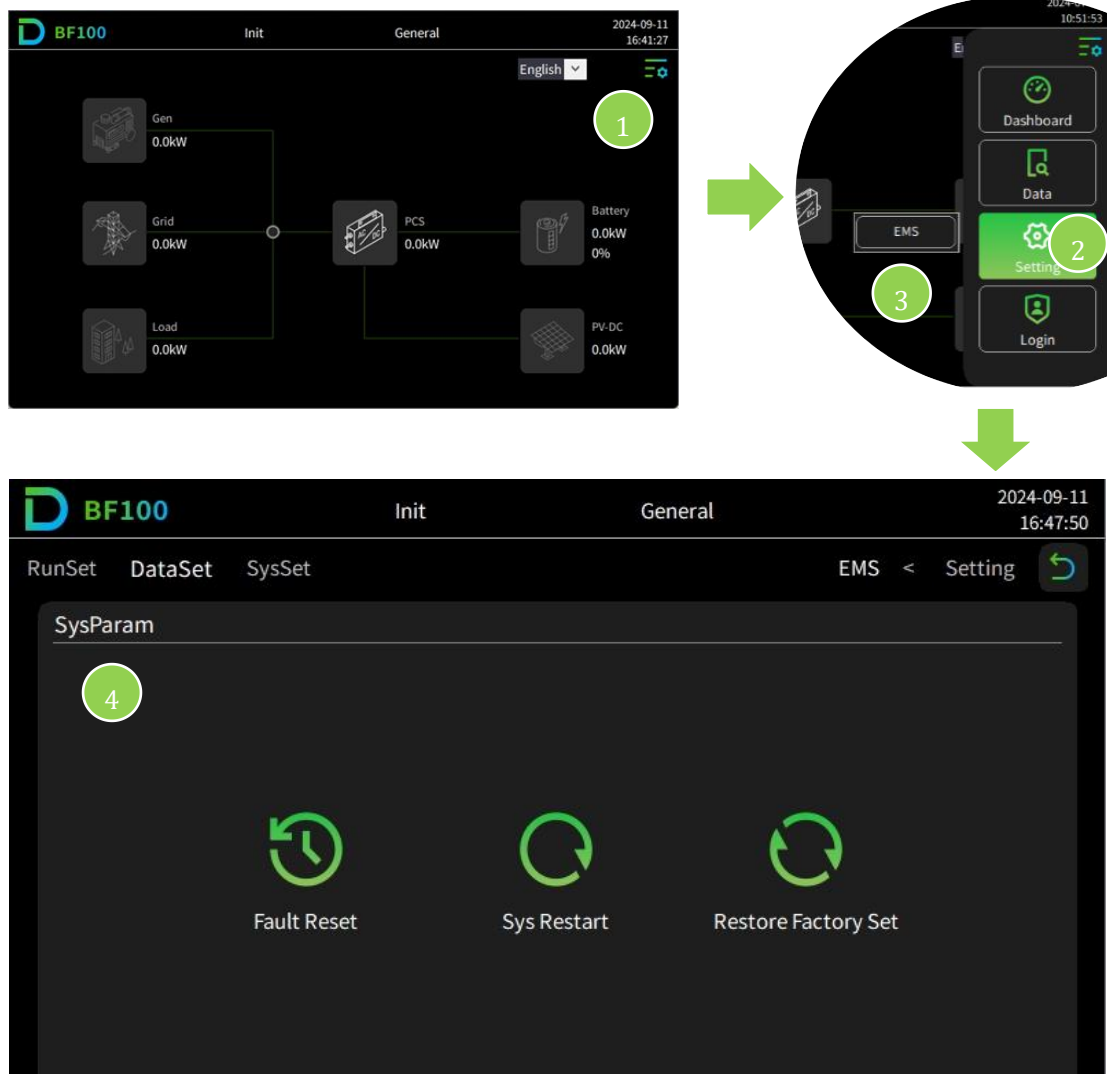



Figure 7-8 Parameter Setting Step

Table 7-3 System Control Description

Item	Description
Fault Reset	Reset for the system faults.
Sys Restart	Restart EMS (Notice: this operation is not possible when the system is running).
Restore factory Set	Safety regulation parameter, correction coefficient, power generation, no clear.

7.5.3. System Setting

Setting the relevant basic parameters of the ESS on system setting interface.

- Step 1: Click main menu icon  on the upper right corner of the main interface;
- Step 2: Click "Setting" under main menu bar;

- Step 3: Click “EMS” under sub-menu bar;
- Step 4: Click “SysSet” at the upper navigation bar and input relevant parameters.

——END

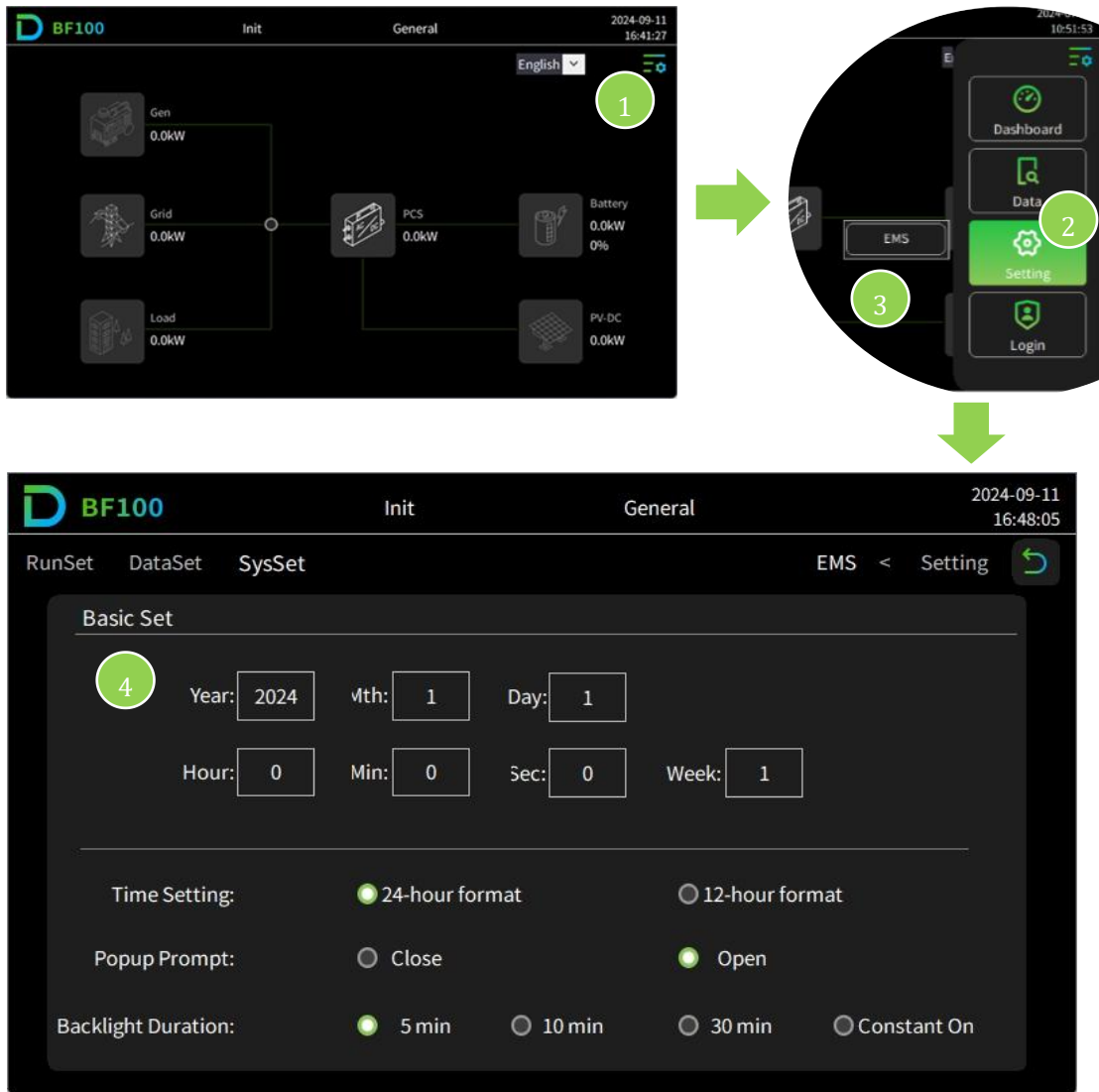

Figure 7-9 System Setting Step

Table 7-4 System Setting Description

Item	Description
HMI time	Set HMI display time
Time Setting	Set HMI display time system, 12-hour and 24-hour available
Popup Prompt	Set HMI popup remind function, set to "open", reminder will popup when setting important parameters.
Backlight Duration	Set HMI backlight time.

8. Fault Description

If the solution provided below still does not solve the problem, please contact Dyness.

Table 8-1 Fault Description And Solution

Fault Phenomenon	Solution
Power light off	<ul style="list-style-type: none"> Check that each circuit breaker is closed.
Running light off	<ul style="list-style-type: none"> Check if EMS is in running state.
Alarm light on	<ul style="list-style-type: none"> Check whether there is any alarm through the screen, App or Web, whether it is caused by improper operation, if not, please contact Dyness after-sales service.
System rattling	<ul style="list-style-type: none"> Check whether the system air inlet and outlet are blocked or have foreign objects, such as rattles in the system inside, contact the manufacturer for after-sales service.
Show access alarm	<ul style="list-style-type: none"> Check if the door is closed.
Show flood alarm	<ul style="list-style-type: none"> Check whether the system is flooded, or whether the water sensor line is disconnected or damaged.
Show emergency stop alarm	<ul style="list-style-type: none"> Check if the EPO button is normal.
Show gas detector alarm	<ul style="list-style-type: none"> Stop using it immediately and contact the manufacturer for after-sales service.
Show temperature detector alarm	<ul style="list-style-type: none"> Stop using it immediately and contact the manufacturer for after-sales service.
Show smoke detector alarm	<ul style="list-style-type: none"> Stop using it immediately and contact the manufacturer for after-sales service.
Show other alarm	<ul style="list-style-type: none"> Need to contact the manufacturer for after-sales.
Abnormal communication between EMS and BMS	<ul style="list-style-type: none"> Shutdown to check if the communication cable is firmly connected and correct; Restart the system and check if it functions normally; If the error message still exists, please contact the manufacturer.
Abnormal communication between EMS and fire protection module	<ul style="list-style-type: none"> Shutdown to check if the communication cable is firmly connected and correct; Restart the system and check if it functions normally; If the error message still exists, please contact the manufacturer.
Abnormal communication between EMS and PCS	<ul style="list-style-type: none"> Shutdown to check if the communication cable is firmly connected and correct; Restart the system and check if it functions normally;

	<ul style="list-style-type: none"> • If the error message still exists, please contact the manufacturer.
Abnormal communication between EMS and air conditioner	<ul style="list-style-type: none"> • Shutdown to check if the communication cable is firmly connected and correct; • Restart the system and check if it functions normally; • If the error message still exists, please contact the manufacturer.
Abnormal communication between EMS and HMI	<ul style="list-style-type: none"> • Check the meter cables after shutdown; • If the error message still exists, please contact the manufacturer.
SD card detect abnormality	<ul style="list-style-type: none"> • Check if the SD card is normal, if not please replace the SD card; • If the error message still exists, please contact the manufacturer.
Network abnormality - (default blocked)	<ul style="list-style-type: none"> • Check the 4G/WIFI/LAN antenna; • If the error message still exists, please contact the manufacturer.
EMS power loss saving abnormality	<ul style="list-style-type: none"> • If the error message still exists, please contact the manufacturer.
EMS external Flash abnormality	<ul style="list-style-type: none"> • If the error message still exists, please contact the manufacturer.
System version inconsistency abnormality	<ul style="list-style-type: none"> • Restart PCS and check if it is normal; • If the error message still exists, please contact the manufacturer.

9. System Maintenance

WARNING

- Operation and maintenance work must comply with the laws and regulations of your region and the precautions in this manual;
- Maintenance of the system must be carried out by qualified operators with knowledge of power and electricity;
- Start inspecting only after the internal equipment of the ESS cabinet is completely powered off during system maintenance! During the inspection, if non-conformance are found, please correct them immediately.

The system needs to be maintained in regular. The maintenance checklist and frequency are listed in the following table.

Table 9-1 System Maintenance Checklist

Items	Checklist	Frequency
Cabinet Exterior	Check if there are any flammable materials on the ESS cabinet;	Once/Year
	Check if the ESS cabinet and expansion bolts are secure and free from rust;	
	Check if there are any damage, peeling paint, and oxidation on the ESS cabinet casing;	
	Check if the cabinet door locks can open smoothly;	
System Status	Check if the sealing strips are securely fixed.	Once/Year
	Check if the ESS cabinet and internal equipment are damaged or deformed;	
	Check if the warning signs and labels are clear and visible. Replace them if necessary;	
	Check if there are any loose or missing screws inside the ESS cabinet;	
Wiring And Cable Arrangement	Check if the cable shielding layer is in good contact with the insulation sleeve, and the grounding copper bar is securely fixed in place;	Once/Year
	Check if there are any oxidation or rust inside the ESS cabinet.	
	Check if all the inlet/outlet of the ESS cabinet are sealed properly;	
	Check if there are any water leakage inside the ESS cabinet;	
	Check if the power cables are loose, tighten them according to previously specified torque;	

	Check if there are any damage for power cables and control cables, especially check for cuts on the insulation where they contact metal surfaces;	
	Check if the insulation wrapping of cable terminals are falling off;	
	Check if the PE cable connection is correct, the grounding resistance value should not exceed 1Ω;	
	Check if the grounding flat steel regularly for rust or corrosion. If there is paint peeling off the situation, need to be sanded and repainted with antirust paint; if there is corrosion, you need to replace the grounding flat steel;	
	Check if the equipotential connections inside the ESS cabinet are correct.	
	Check if the inlet/outlet of ESS cabinet are blocked. Please clean them if needed;	
	Check if the humidity inside is ESS cabinet is within the normal range, please clean them if needed;	
System Cleanliness	Check if there are foreign objects, dust, dirt and condensation inside the ESS cabinet;	Once/ Half year
	Check if there are condensation inside the ESS cabinet regularly: Once a year for areas with low relative humidity; One half year for areas with medium relative humidity; Once every one to three months for areas with high relative humidity.	
System Function	Check if there are abnormal noise inside the ESS cabinet during operation;	Once/ Two years
	Check if the temperature is too high inside the ESS cabinet;	
	Check if the system operates normal for startup and shutdown.	
Air Conditioner	Check the operation status of air conditioner;	
	Check if the air conditioner is blocked;	Once/Year
	Check if there are abnormal noise during air conditioner operation.	
Safety Function	Check the stop function of EPO and screen, and simulate shutdown for test;	Once/Half year~Year
	Check the warning signs and other labels, please replace them if there are any damage or blur.	

	Perform a regular inspection for rust condition of all metal components (once every half year);	
Device	Annual inspection of the contactor (auxiliary switch and	Once/Half
Maintenance	micro-switch) to ensure that the product runs well;	year~Year
	Check the operating parameters (especially voltage and insulation parameter).	

10. Quality Assurance

Warranty period please refer to "Technical Agreement" and "Warranty Agreement"

Service within warranty period: For Dyness ESS products that fail within warranty period, we will be responsible for handling and providing proper replacement or repair solution, offering free services or replacement of failure products. We will require valid invoices and receipts of purchase for warranty. Meanwhile, the Dyness trademark should be visible to ensure the validity of assurance.

We reserve the right not to provide warranty in the following situations:

- The ESS products exceed the free warranty period;
- Improper installation, modification or usage;
- Operation under harsh environments beyond those specified in this document or "Warranty Agreement" or "Technical Agreement", or damage caused by abnormal natural environmental factors;
- Damage or failure caused by installation, modification and disassembly from unauthorized agencies or individuals;
- Damage or failure caused by the use of non-standard products or unauthorized components and software.

For failures caused by the above situations, Dyness could provide paid maintenance services if customer require.

If you have any problems about this product, please contact us. In order to solve your problem more quickly, please provide the following information:

- Original purchase receipt or invoice;
- Contact information, including name, phone number, email address and shipping address;

Product information, including product model, product serial number, installation date and location, fault date and fault description, etc.

11. Appendix

In order to better serve users, please check if the following checklist have been completed before product runs.

Items	Checklist	Confirm
1	Check if the appearance is damaged and if the internal equipment is intact;	<input type="checkbox"/>
2	Check if the assembly is firm;	<input type="checkbox"/>
3	Check if the logo and labels of ESS cabinet and components are clear or damaged;	<input type="checkbox"/>
4	Check if the communication cable connection is completed;	<input type="checkbox"/>
5	Check if there are any faults of PE cable;	<input type="checkbox"/>
6	Check if the liquid cooling pipes are well connected and check if there are any leakage;	<input type="checkbox"/>
7	Check if the meter reads correctly;	<input type="checkbox"/>
8	Check if all the connection points are correct and have good contact;	<input type="checkbox"/>
9	Check if there are no abnormal situation of manual components;	<input type="checkbox"/>
10	Check if the circuit breakers functioning normally;	<input type="checkbox"/>
11	Check if all the buttons and related indicators are functioning normally;	<input type="checkbox"/>
12	Check if the power indicator is normal;	<input type="checkbox"/>
13	Check if the running indicator is normal;	<input type="checkbox"/>
14	Check if fan and air conditioner is running well and no abnormal sound;	<input type="checkbox"/>
15	Check if the HMI screen is normal and there are no error messages;	<input type="checkbox"/>
16	Check if there are any tools or components left inside the ESS cabinet.	<input type="checkbox"/>

DYNES

DISCOVER YOUR NATURE

Address: No. 511 Chenzhuang West Road, Sanshui Street,
Jiangyan District, Taizhou City

Email: service@dyness-tech.com

Tel: +86 400 666 0655

Web: www.dyness.com



Official Website



Digital version access